

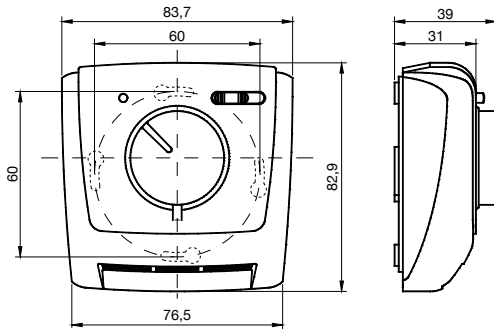
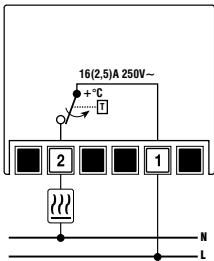
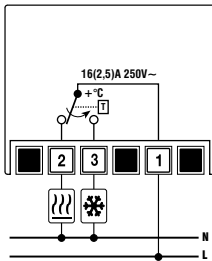
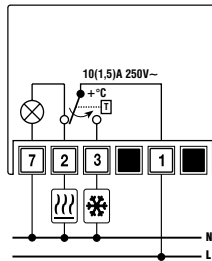
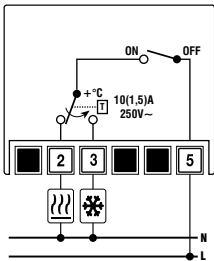
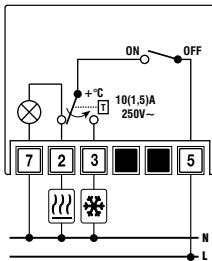
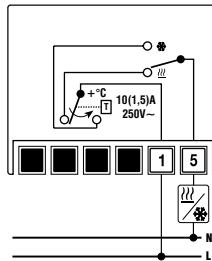
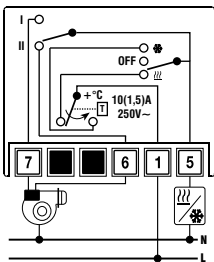
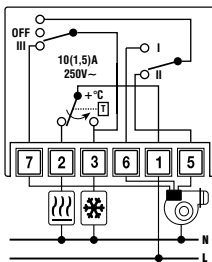

Vemer S.p.A.

I - 32032 Feltre (BL) • Via Camp Lonc, 16  
e-mail: info@vemer.it - web site: www.vemer.it

**DIMENSIONS****CONNECTIONS****KLIMA 2****KLIMA 3****KLIMA 3L****KLIMA IN****KLIMA SI****KLIMA SW****KLIMA 2V****KLIMA 3V**

**Note:**  
for "heating" operation mode, remove the cable terminal which is inside the device from terminal 3 to terminal 2.

**User Manual****AMBIENT GAS MEMBRANE THERMOSTAT**

⚠ **Read all the instruction carefully**

- This thermostat is designed to regulate the temperature in domestic and industrial environments.

**SAFETY WARNINGS**

- **During installation and operation of the device, it is necessary to comply with the following instructions:**
  - 1) **The device must be installed by a skilled person, in strict compliance with the connection diagrams**
  - 2) **Do not power on or connect the device if any part of it is damaged**
  - 3) **After installation, inaccessibility to the connection terminals without appropriate tools must be granted**
  - 4) **The device must be installed and activated in compliance with current electric systems standards**
  - 5) **Before accessing the connection terminals, verify that the leads are not live**

| Code     | Model    | Contact | Functions                      |
|----------|----------|---------|--------------------------------|
| VE018800 | KLIMA 2  | NA      | -                              |
| VE019600 | KLIMA 3  | NA + NC | -                              |
| VE020400 | KLIMA 3L | NA + NC | Power on warning lamp          |
| VE021200 | KLIMA SI | NA + NC | ON/OFF + Power on warning lamp |
| VE022000 | KLIMA IN | NA + NC | ON/OFF                         |
| VE023800 | KLIMA SW | NA + NC | Summer/Winter                  |
| VE024600 | KLIMA 2V | NA + NC | 2 speed + Summer/Winter/OFF    |
| VE268900 | KLIMA 3V | NA + NC | 3 speed + OFF                  |

**TECHNICAL SPECIFICATIONS**

- Free mounted single-pole mechanical thermostat
- Setting range: +5 / +30°C
- Differential:  $\Delta t \leq 1^\circ\text{C}$
- Capacity of the contacts: 16(2,5)A 250V ~ for models KLIMA 2 e KLIMA 3  
10(1,5)A 250V ~ for models KLIMA 3L, KLIMA SI, KLIMA IN, KLIMA SW, KLIMA 2V, KLIMA 3V
- Thermal gradient: 1°C / 15 min.
- Sensitive element: vapour expansion lung
- Class I equipment
- Protection degree: IP20
- Type of action: 1B
- Silver contacts 1000/1000
- Break or switching contacts
- Pollution degree: 2 (normal)
- Voltage pulse: 4kV
- Operating temperature: 0 ÷ 40°C
- Operating humidity: 20 ÷ 90 %RH noncondensing

**INSTALLATION**

- The thermostat should be fitted at approximately 1.5 m from the ground avoid positioning it near doors, windows, sources of heat and in places where there is too much or too little ventilation.

- 1) The thermostat can be fitted directly to the wall or to the flush-mounting box (centre distance 60 mm).
- 2) Remove the knob, unscrew the screw of the cover and remove it

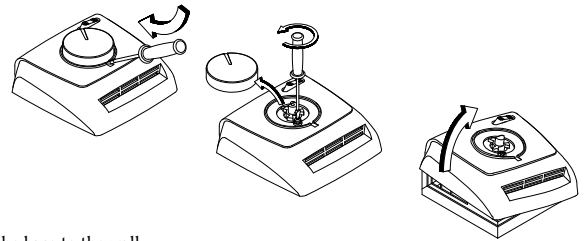

- 3) a) fix the base to the wall  
b) connect the thermostat earth by using the terminal marked with the earth symbol  
c) follow the wiring diagram inside the cover; fix the flexible inseparable wires to the relative screw terminals  
d) replace the cover, screws and knob.

**USER'S GUIDE**

- 1) Set the temperature required by turning the knob;
- 2) To limit the setting field:
  - a) Isolate the power supply line
  - b) Remove the knob
  - c) Insert the limit markers in the housing under the knob (17°C ÷ 23°C)
  - d) Return the knob to its housing.

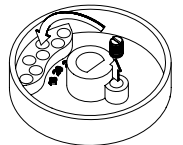

information to users pursuant to art. 14 of the directive 2012/19 / EU of the european parliament and of the council of 4 July 2012 on waste electrical and electronic equipment (WEEE)

If the crossed-out bin symbol appears on the equipment or packaging, this means the product must not be included with other general waste at the end of its working life.

The user must take the worn product to a sorted waste center, or return it to the retailer when purchasing a new one.

Products for disposal can be consigned free of charge (without any new purchase obligation) to retailers with a sales area of at least 400 m<sup>2</sup>, if they measure less than 25 cm.

An efficient sorted waste collection for the environmentally friendly disposal of the used device, or its subsequent recycling, helps avoid the potential negative effects on the environment and people's health, and encourages the re-use and/or recycling of the construction materials.

**REFERENCE STANDARDS**

Conformity with EU directives: 2014/35/EU (LVD), 2014/30/EU (EMCD) is declared with reference to the following standard: **EN 60730-2-9**