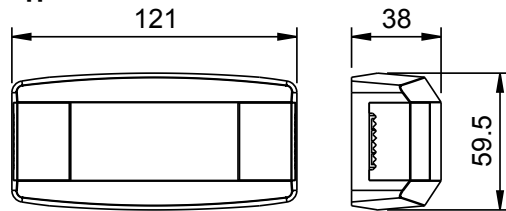
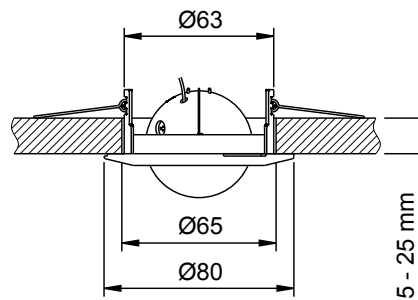
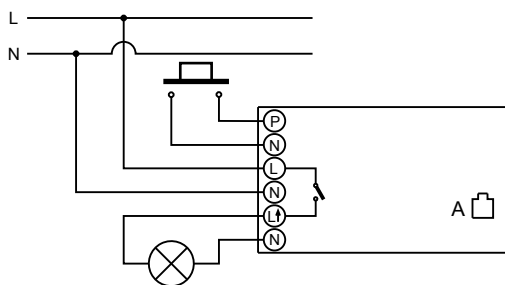
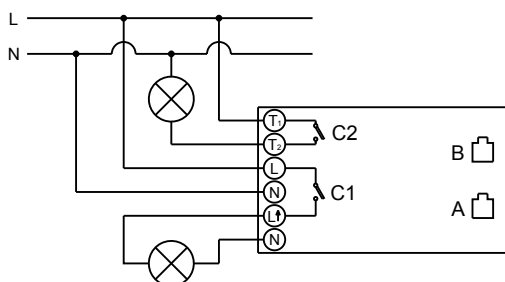
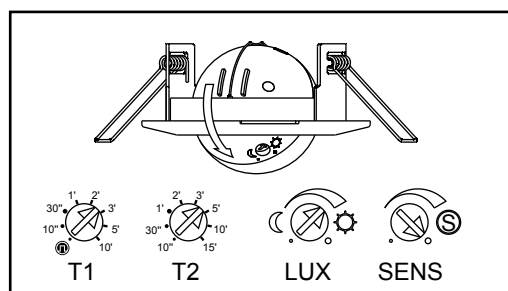

**Dimensions****Power supplier****Sensor****Connection diagrams****Sensor-T****Sensor-2T****Description**

User manual

Movement detectors

Read all instructions carefully

- The **Sensor-T** and **Sensor-2T** proximity switches are electronic switching devices containing micro-disconnection (μ) according to EN 60669-2-1. The output circuit is activated when a heat source moves in front of the device and is deactivated when no movement is intercepted, after an adjustable period of time. Sensor-2T also has a second output circuit that functions independently from the level of lighting.

SAFETY WARNINGS

During product installation and operation it is necessary to observe the following instructions:

- 1) The instrument must be installed by a qualified person, in strict compliance with the connection diagrams**
- 2) Do not power the instrument if any part of it is damaged**
- 3) The instrument must be installed and activated in compliance with current electric system standards**
- 4) The electrical system in the building in which the instrument is to be installed should have an over-current switch and a protection device**
- 5) The instrument can be used in environments with pollution degree 2**
- 6) Before accessing the connection terminals, verify that the leads are not live**
- 7) After installation, inaccessibility to the connection terminals without appropriate tools must be guaranteed.**

Code	Model	Description
VE215000	Sensor-T	Ceiling movement detector
VE216800	Sensor-2T	Ceiling movement detector

TECHNICAL CHARACTERISTICS

- Power supply: 230V AC 50-60 Hz
- Relay contacts capacity at 250 V AC: 10 A (resistive load)
- Sensor-T:**
 - Load (L1-N) for lighting:
 - Incandescent Light: 2200W
 - Halogen Light 230V: 2200W
 - Low Voltage Halogen Light: 2000VA
 - Fluorescent Light: 1200VA
 - Energy Saving Lamp (CFL): 1000VA
 - LED Lamp: 500 VA
- Sensor-2T:**
 - Load (L1-N) for lighting:
 - Incandescent Light: 2200W
 - Halogen Light 230V: 2200W
 - Low Voltage Halogen Light: 2000VA
 - Fluorescent Light: 1200VA
 - Energy Saving Lamp (CFL): 1000VA
 - LED Lamp: 500VA
 - Consumation:
 - Sensor T: 7VA capacitive (ca. 1,1W)
 - Sensor 2T: 4,2VA inductive (ca. 3,1W)
 - Luminosity range: 10-1000 lux
 - Timing range:
 - Sensor-T: T1: from 1s to 10 minutes
 - Sensor-2T: T1: from 10s to 10 minutes, T2: from 10s to 15 minutes
 - Detection angle: 360°
 - Detection field: up to 7m in diameter to 2.5m in height
 - Operating temperature: -10 °C ÷ +45 °C
 - Type of protection: IP20
 - Degree of protection: Class II

INSTALLATION

- The device must be installed far away from inductive loads (motors, transformers, telephone aeriels, transformation stations, industrial machinery, etc.) inasmuch as particularly strong magnetic fields could affect its operation. Do not mount on conductive surface. The device must also be protected against rain and the sun's rays and should not be placed near lamps or heat sources. The device should not be secured to the ceiling in the vicinity of highly reflective surfaces or elements subject to sudden temperature changes or light sources.
- Make a hole with a diameter of 65 mm in the material to support the device (the material must be between 5 and 25 mm thick). Open the cover on the supply module that covers the compartment of connection terminals, then connect the power supply and the load according to the wiring diagrams, close the cover after checking the connections made. Then open the cover which is located on the opposite side of the power supply module in order to connect the product simply by hooking the special connector. Then introduce the power supply module in the hole prepared for the insertion of the sensor. Secure the sensor using the springs, lifting it upwards and inserting it inside the hole, pushing the sensor in until the edge rests against the ceiling.

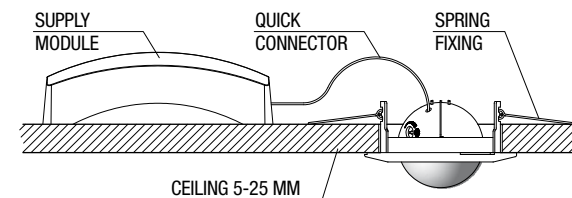

- You should also bear in mind that detection takes place where the two axes cross over and therefore, if the heat source moves in parallel to the axes, the detection will take place at a shorter distance.

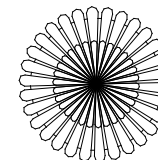
LESS SENSITIVITY

direction of movement

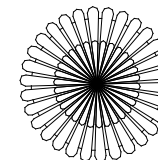
GREATER SENSITIVITY

direction of movement

- If two Sensor-T/2T are connected in the same room, the lamp of one should not be positioned in the detection field of the other.

OPERATION

- A screwdriver can be used to adjust the various parameters via the trimmer (3 for the Sensor-T, 4 for the Sensor-2T).
- To adjust the detection field, turn the "LUX" knob to the position "*" and the "T1" knob to the minimum position (in the case of Sensor-2T, turn also the knob "T2"). Now move inside the limits of the detection field and take action on the potentiometer "SENS" if necessary in order to adjust the coverage area. The sensor can move into six positions, guaranteeing an angle of up to 30°. It can rotate by 350°. The device comes with an accessory that makes it possible to limit the device's field of action. This accessory is divided into twelve sectors, with two different heights. Each sector makes it possible to block an area of 30°. The sensors have a red light inside them that turns on once the detection occurred. Then you can use this LED as an aid for adjusting the detection field without the need to connect a load.
- The luminosity can be adjusted using the "LUX" knob, which makes it possible to set the device so as to guarantee interventions only in conditions of luminosity below the set level. By turning the knob to position "*" the output circuit is activated in any condition of luminosity, while in position "C" it is only activated in conditions of low luminosity. The second output circuit of Sensor-2T operates independently from the set level.
- The "T1" knob makes it possible to set the period of time in which to keep the load activated following the detection of movement. The timer range starts from a minimum of 1 second to a maximum of 10 minutes. The Sensor-2T has a second output circuit that activates in case movement is intercepted within the coverage area and that works with any condition of luminosity. The de-excitation time available only on Sensor-2T, may be within the range of 10 seconds and 15 minutes with the knob "T2".
- In the Sensor T there is the possibility to manual activate the load for the time T1 closing the clean contact (between N and P). In this way the load will turn on without the sensor has detected something and with any condition of luminosity.
- Turn off power when change the light sources.

REFERENCE STANDARDS

Conformity to the EU directives:
2014/35/EU (LDV)
2014/30/EU (EMCD)
is declared with reference to harmonized standard:
EN 60669-2-1



information to users pursuant to art. 14 of the directive 2012/19 / EU of the european parliament and of the council of 4 July 2012 on waste electrical and electronic equipment (WEEE)

If the crossed-out bin symbol appears on the equipment or packaging, this means the product must not be included with other general waste at the end of its working life.

The user must take the worn product to a sorted waste center, or return it to the retailer when purchasing a new one.

Products for disposal can be consigned free of charge (without any new purchase obligation) to retailers with a sales area of at least 400 m², if they measure less than 25 cm.

An efficient sorted waste collection for the environmentally friendly disposal of the used device, or its subsequent recycling, helps avoid the potential negative effects on the environment and people's health, and encourages the re-use and/or recycling of the construction materials.