

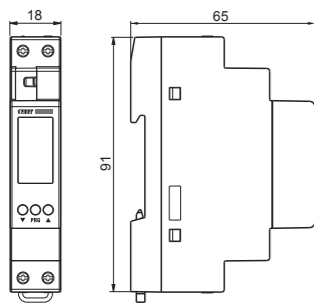

2 DIMENSIONS

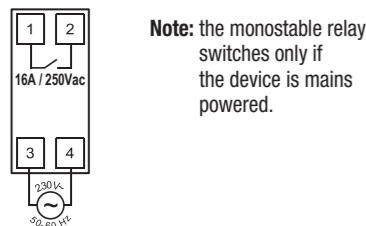

3 CONNECTION DIAGRAM



Note: the monostable relay switches only if the device is mains powered.

4 DISPLAY DESCRIPTION

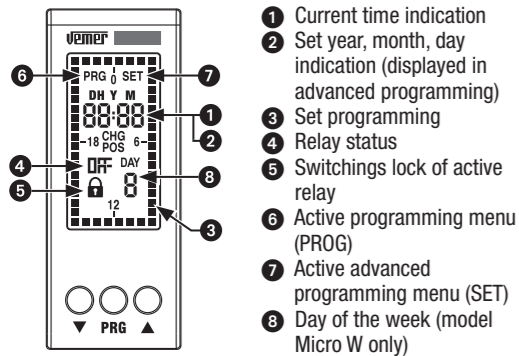

- 1 Current time indication
- 2 Set year, month, day indication (displayed in advanced programming)
- 3 Set programming
- 4 Relay status
- 5 Switchings lock of active relay
- 6 Active programming menu (PROG)
- 7 Active advanced programming menu (SET)
- 8 Day of the week (model Micro W only)

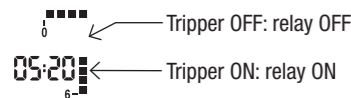

5 INSTALLATION

The device comes with the inserted battery and the set date. It is possible to awaken the device (display activation without backlighting) by pressing **PRG** key. Connect power supply and relay output as reported in the "connection diagrams". The backlighting will turn on as soon as the device is powered and remains always on (in the presence of mains power).

1 User manual DIGITAL TIME SWITCH WITH TRIPPERS

Read all instructions carefully

Electronic time switches with daily programming (**Micro D**) or weekly (**Micro W**) for control of an electrical load. Join the accuracy of digital switches to the simple programming of the electromechanical switches with trippers. The cover on the front of the device allows battery replacement once depleted. They are electronic devices that perform actions of 1B type and are designed to operate in environments with overvoltage category III and pollution degree 2 according to EN 60730-1 standard.

Codice	Modello	Descrizione
VE758100	Micro D	Time switch with daily programming 1 DIN module
VE758200	Micro W	Time switch with weekly programming 1 DIN module

SAFETY WARNINGS

- During product installation and operation it is necessary to observe the following instructions:
- 1) The device must be installed by a qualified person, in strict compliance with the connection diagrams.
 - 2) Do not power the device if any part of it is damaged.
 - 3) The device must be installed and activated in compliance with current electric system standards.
 - 4) A protection device against over-currents should be installed in the electrical system, upstream of the device.
 - 5) Before accessing the connection terminals, verify that the leads are not live.
 - 6) After installation, inaccessibility to the connection terminals without appropriate tools must be guaranteed.
 - 7) In case of malfunction do not perform repairs and contact immediately the technical support.

TECHNICAL CHARACTERISTICS

- Power supply: 230 Vac (-15% ÷ +10%) 50/60 Hz
- Absorption: 5.5 VA (1 W)
- Output: normally open relay from 16 A / 250 Vac
- Terminals for max 4 mm² cables section
- Programming:
 - Micro D: daily (the same program performed every day)
 - Micro W: weekly (a different program for every day of the week)
- Resolution of programming: 30 minutes
- Summer/winter time automatic update (removable) depending on the geographical zone of installation (Europe, North America, Australia, Chile, New Zealand)
- Active backlighting display with mains power
- Replaceable CR-1632 type backup battery (duration: 4 years about)
- Operating temperature: -20 ÷ +50 °C
- Storage temperature: -10 ÷ +70 °C
- Operating humidity: 20÷90% non condensing
- Container: 1 DIN module
- Degree of protection: IP20

6a MICRO D PROGRAMMING

Micro D programming consists of a single program to be repeated every day. The program is defined by the position of 48 trippers (one every 30 minutes), which can be ON (relay on) or OFF (relay off). When you first start the trippers are all OFF (relay off).

To modify the program:

1. from the main page press **PRG** key
2. the programming starts from the tripper that corresponds to the current time
3. press the key **▼** or **▲** to set the tripper (**▲** = relay on, **▼** = relay off) and press **PRG** to confirm and step up of 30 minutes (to the next tripper)
4. once the desired programming is got, press **PRG** key for at least 3 seconds to exit and return to the main page.

Note: you can exit programming even if you don't press any key within the time-out (40 seconds if the device is mains powered, 10

6b MICRO W PROGRAMMING

Micro W programming consists of 7 different programs, one for each day of the week. Each program is defined by the position of 48 trippers (one every 30 minutes), which can be ON (relay on) or OFF (relay off). When you first start the trippers of all programs are OFF (relay off).

To modify the programming:

1. from the main page press **PRG** key. The day 1 (Monday) flashes
2. choose the day of the week to modify (1 = Monday, ..., 7 = Sunday) with the keys **▲** and **▼** and confirm by pressing **PRG**
3. programming starts from midnight (00:00) of the selected day
4. press the keys **▲** or **▼** to set the tripper (**▲** = relay on, **▼** = relay off) and press **PRG** to confirm and step up of 30 minutes (to the next tripper)
5. once the desired programming is got for that day, press **PRG** key for at least 3 seconds to exit and return to the choice of the day
6. repeat steps 2, 3, 4, 5 until all days of the week have been programmed
7. once the desired programming is got, press **PRG** key for at least 3 seconds to exit and return to the main page

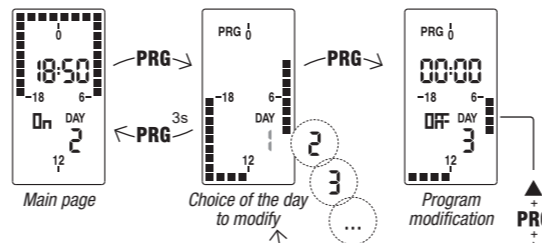

Note: you can exit programming even if you don't press any key within the time-out (40 seconds if the device is mains powered, 10 seconds if powered by the backup battery). The modifications are still saved.

Copy function

The copy function allows you to copy in any day the programming of another day.

To copy an existing program in another day:

1. access modification menu of the day concerned (points 1, 2, 3 of the simple programming)
2. press simultaneously the keys **▲** and **▼**. The word **COPY** appears on the display and the day to copy flashes
3. choose which day to copy with the keys **▲** and **▼** and confirm with **PRG** key.

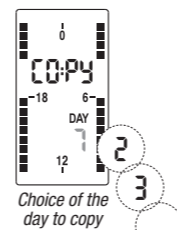

Display date and programs

From the main page, by pressing the key **▲** it's possible to display in succession the programs of every single day and then the set date (day and month). To move from one program to the next, press the key **▲**.

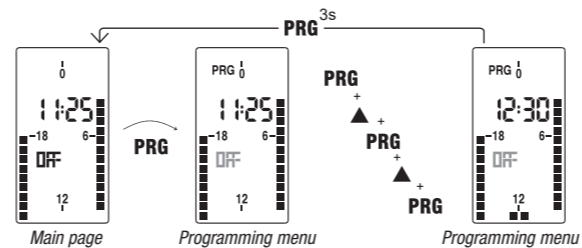

seconds if powered by the backup battery). The modifications are still saved.

Display date

From the main page, by pressing the key **▲** it's possible to display the set date (day and month).

7 ADVANCED PROGRAMMING

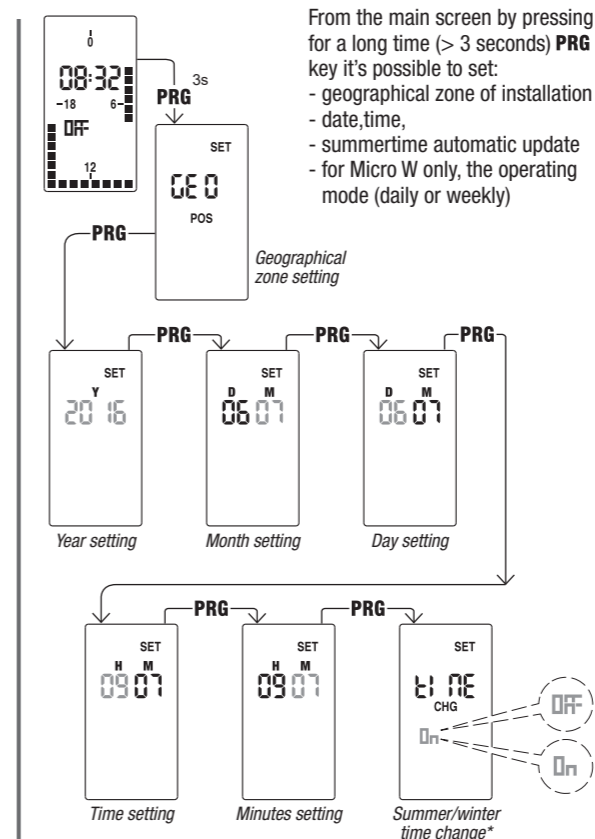

From the main screen by pressing for a long time (> 3 seconds) **PRG** key it's possible to set:

- geographical zone of installation - date, time,
- summertime automatic update
- for Micro W only, the operating mode (daily or weekly)

(*) summer/winter time change

If the automatic update of summer time is active (on), the change occurs according to the set geographical zone:

Zone	Start DST (+1h)	End DST (-1h)
01 Europe	Last Sunday, March	Last Sunday, October
02 North America	Second Sunday, March	First Sunday, November
03 Australia	First Sunday, October	First Sunday, April
04 Chile	Second Sunday, October	Second Sunday, March
05 New Zealand	Last Sunday, September	First Sunday, April

Note: time change is fixed for all zones at 2:00 o'clock for the start of DST and at 3:00 o'clock for the end of DST.

Operating mode (Micro W only)

In Micro W after "summer/winter time change" menu, the menu for the operating mode choice is accessed: daily (1) or weekly (7). If set as daily, Micro W works like a Micro D, running every day the same program.

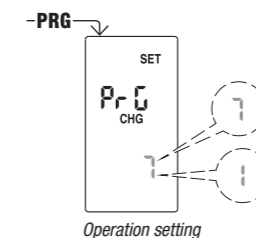

Note: you can exit programming even if you don't press any key within the time-out (40 seconds if the device is mains powered, 10 seconds if powered by the backup battery). In this case the modifications are not saved.

8 RELAY MANUAL SWITCHING

To change manually the status of relay output (from ON to OFF or vice versa) press the key **▼**. **Attention:** the status is maintained until new press of the key **▼** or until the next program switching.

To lock the current status of the relay and prevent its switchings, press for a long time (> 3 seconds) the key **▼**. In this condition the symbol **☒** is lit. Unlocking is done by pressing for a long time the key **▼**.

9 DEPLETED BATTERY

When the backup battery is low the device displays **BAE** CHG alternating with the main page. In this condition, replace the battery as soon as possible, by accessing the battery compartment to avoid that, in case of blackout, the date and time are lost.

Dispose of used batteries in accordance with the current legal provisions regarding the disposal of hazardous waste.

Attention: before you access the battery compartment, disconnect the power supply. **Attention:** perform the operation in a maximum time of one minute in order not to lose date and time. Use only CR-1632 type battery.

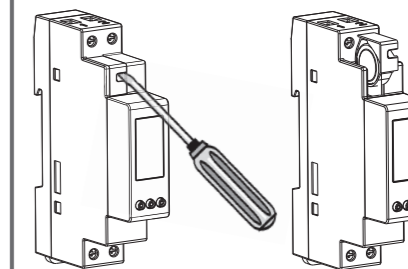

10 DEFAULT PARAMETERS

The default of the parameters shows the device factory conditions, that is to say:

- geographical zone: 1 (Europe)
- summer time automatic change: active
- programming: always OFF

To perform the default, from the main screen press simultaneously for at least 3 seconds the keys **▲**, **PRG** and **▼** and, during **dEF** flashing, confirm by pressing **PRG** key.

Attention: if during **dEF** flashing you don't press any key within 5 seconds, the device returns to the main screen without perform the reset.

REFERENCE STANDARDS

Compliance with Community directives: 2014/35/EU (LVD), 2014/30/EU (E.M.C.D.) is declared in reference to the following harmonised standards: • EN 60730-2-7