



Vemer S.p.A.
I - 32032 Feltre (BL) • Via Camp Lonc, 16
e-mail: info@vemer.it - web site: www.vemer.it

Manuals
download



2 INSTRUMENT DESCRIPTION and DIMENSIONS

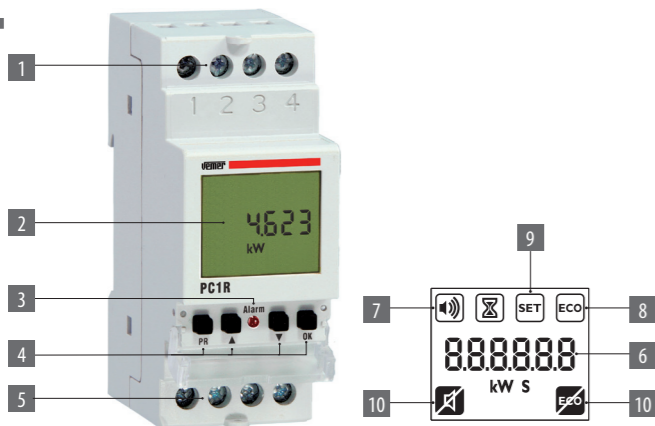

- 1 Terminals for power supply and current measurement
- 2 Backlit display (for 30 s from the pressure of one key)
- 3 Red led: on indicates disconnected load
- 4 Programming keys
- 5 Relay terminals
- 6 Measured power
- 7 Active buzzer (Tbe)
- 8 Disconnected load
- 9 Setpoint is exceeded
- 10 Icons for text guide keys function
 - (PR) buzzer silencing
 - (OK) disconnected load rejection

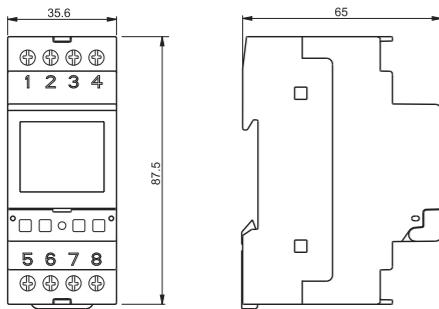

1 User Manual LOADS CONTROL 1 RELAY

Read all the instructions carefully

Electronic instrument to measure the consumption of active power in single-phase systems to prevent the activation of the limiter switch of general current for overload.
PC1R provides for the disconnection of a not priority load if the consumption of measured power is higher than the prefixed threshold (setpoint) continuously for a time of settable pre-alarm (Ton). The connection of the load occurs after a disconnection time (Toff).

Code	Model	Description
VE475000	PC1R	Loads control 1 relay

SAFETY WARNINGS

- During the installation and the operation of the instrument it's necessary to observe the following instructions:
- 1) The instrument must be installed by a qualified person by observing scrupulously the connection diagrams.
 - 2) The instrument must be installed and activated in compliance with current electric systems standards.
 - 3) After installation, inaccessibility to the connection terminals without appropriate tools must be granted.
 - 4) Do not use the instrument for other purposes different from the one specified.
 - 5) The instrument must be installed in a closed electrical panel adequately protected.
 - 6) In the power supply network a bipolar disconnection must be present.
 - 7) A protection device against over-currents should be installed in the electrical system, upstream of the device.
 - 8) Before accessing the connection terminals, verify that the leads are not live.
 - 9) Do not power on or connect the instrument if any part of it is damaged.
 - 10) In case of malfunction do not perform repairs and contact immediately the technical support.
 - 11) The instrument can be used in environments with category of measurement III and pollution degree 2, as per standards EN 61010-1.

TECHNICAL CHARACTERISTICS

- Power supply: 230 Vac (-15% ÷ +10%) 50/60 Hz
- Maximum own consumption: 4 VA
- Direct current connection until 32 A through shunt
- Settable setpoint range: 0,8 ÷ 7 kW
- Pre-alarm time range Ton: 0 ÷ 9999 seconds
- Buzzer time range Tbe: 0 ÷ Ton seconds
- Disconnection time range Toff: 0 ÷ 9999 seconds
- Output: 1 monostable relay with exchange contact 16 A / 250 Vac
- Blocks for cables with maximum section of 6 mm²
- Operating temperature: -10°C ÷ 45°C
- Operating humidity: 10% ÷ 90% non condensing
- Storage temperature: -10°C ÷ 65°C
- Container: 2 modules DIN
- Protection degree: IP20 / IP40 (on the front panel)
- Insulation: reinforced between accessible parts (front panel) and all other terminals
- Type of actions: 1B

Setpoint is exceeded

If the power is higher than the set threshold, the symbol and the measured value flash and buzzer is activated for **Tbe** duration.
After **Ton** seconds (pre-alarm phase) the load is disconnected.

Rejection of load disconnection

During the phases of pre-alarm (**Ton**) and alarm (**Toff**) it's possible to reject the disconnection of the load by pressing the key . The duration of the disconnection rejection is 9999 seconds (2,5 hours about) and it's not modifiable. This condition is indicated by the switch on of the symbol .

Note: once this function is activated, if you want the load is disconnected before the 9999 seconds, it's necessary to switch off and to switch on the power supply of the instrument.

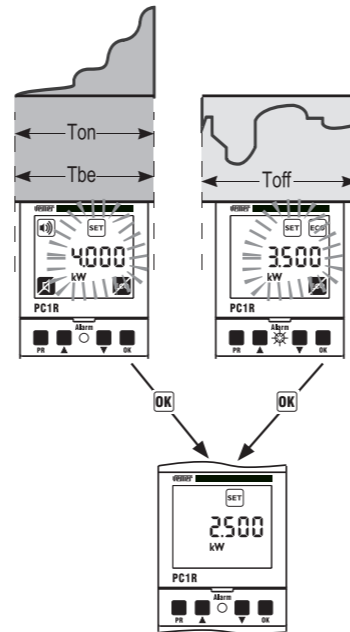

3 INSTALLATION

To prevent the disconnection of all loads downstream of the general counter, the loads control PC1R must measure the same current of the energy meter. For this reason the ideal position for the connection of the instrument is immediately downstream of the general switch.

Two loads or groups of loads must be located and so divided:

- **not disconnectable loads**, that is to say loads which can't be disconnected and that can't be controlled by PC1R (even if their consumption must be measured by PC1R to determine the total consumption)e)
- **disconnectable loads**, which can be disconnected if the absorbed power is higher than the prefixed threshold.

Note: PC1R can be used also as a generic controller of absorbed power by loads under control by placing it upstream of the cable for power supply of loads themselves. Clearly with this second application it's not possible to prevent the disconnection of the general energy meter, because the absorptions of the loads not controlled by PC1R are not counted.

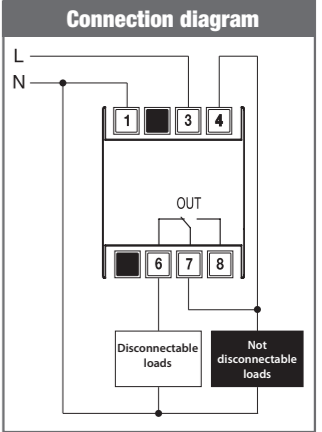

4 OPERATION AND PROGRAMMING

DEFINITION AND MODIFICATION OF OPERATION PARAMETERS

- **Setpoint** [kW] represents the activation threshold that is to say the maximum value of accepted consumption. Over this value the instrument provides for the disconnection of the load.
 - **Ton** [seconds] represents the pre-alarm time, that is to say how long the power must be higher than the setpoint before the load is actually disconnected.
 - **Tbe** [seconds] represents the time of audible alarm, that is to say how many seconds the buzzer must sound during the pre-alarm phase.
 - **Toff** [seconds] represents the disconnection time, that is to say after how long the load is reconnected.
- Note: the load is connected only if the absorbed power is lower than the Setpoint.

OPERATION LOGIC

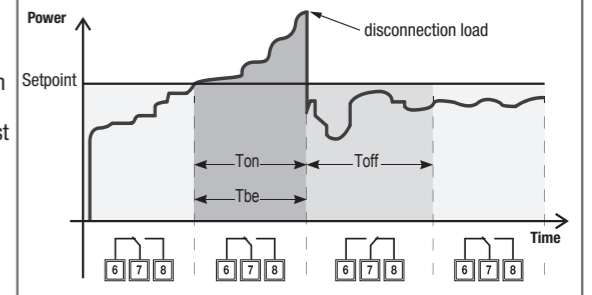

PROGRAMMING

To access the modification of the operation parameters display press the key . Use the key and to move within the menu and press to access parameter modification. Use the key and to set the desired value and press the key to confirm and move on to the next parameter or to exit programming.

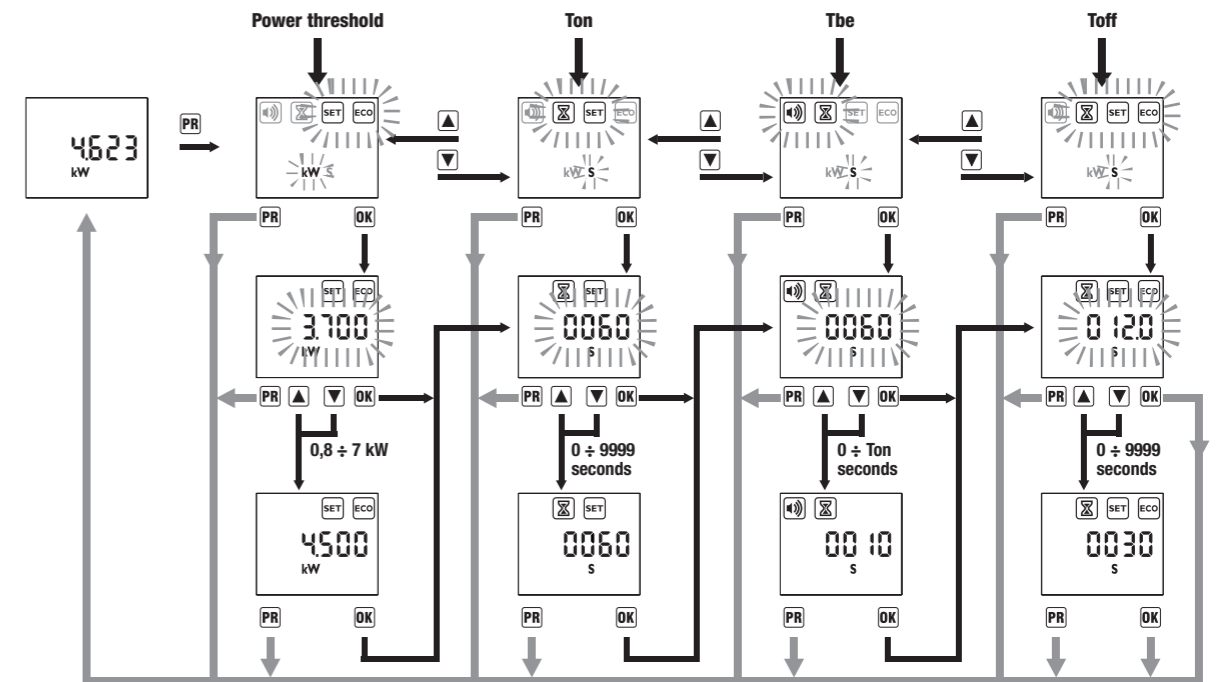

Buzzer silencing

During the phase of pre-alarm the buzzer can be silenced by pressing the key .

Reset parameters

To restore the default parameters, press the keys and simultaneously for 3 seconds at least.
The default values are:

- Setpoint: 3.7 kW
- Ton: 60 seconds
- Tbe: 60 seconds
- Toff: 120 seconds

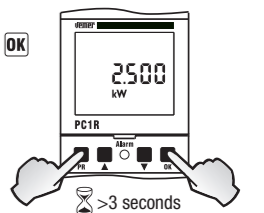

Information to users pursuant to art. 14 of the directive 2012/19 / EU of the European Parliament and of the Council of 4 July 2012 on waste electrical and electronic equipment (WEEE)

If the crossed-out bin symbol appears on the equipment or packaging, this means the product must not be included with other general waste at the end of its working life.

The user must take the worn product to a sorted waste center, or return it to the retailer when purchasing a new one.

Products for disposal can be consigned free of charge (without any new purchase obligation) to retailers with a sales area of at least 400 m², if they measure less than 25 cm.

An efficient sorted waste collection for the environmentally friendly disposal of the used device or its subsequent recycling, helps avoid the potential negative effects on the environment and people's health, and encourages the re-use and/or recycling of the construction materials.

01-2024

REFERENCE STANDARDS

Compliance with Community Directives: 2014/35/UE (LVD) and 2014/30/UE (EMCD) is declared with reference to the following standards:
• EN 61010-1 • EN 61000-6-2 e 61000-6-3