



Mod. Simply AST

Vemer S.p.A.

I - 32032 Feltre (BL) • Via Camp Lonc, 16
e-mail: info@vemer.it - web site: www.vemer.it



2 DIMENSIONS

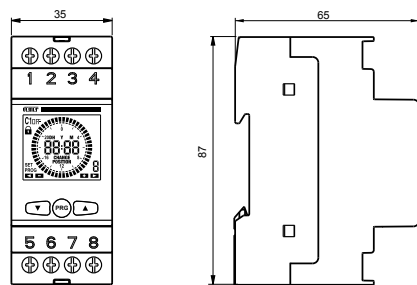

3 CONNECTION DIAGRAM

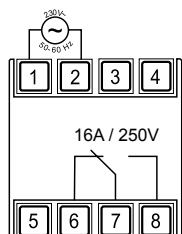

Note: the monostable relay switches only if the instrument is mains powered.

4 DISPLAY DESCRIPTION

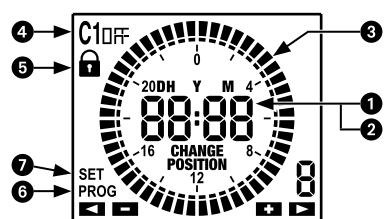

- 1 Current time indication
- 2 Set year, month, day indication (displayed in advanced programming)
- 3 Set programming
- 4 Relay status
- 5 Switchings lock of active relay
- 6 Active programming menu (PROG)
- 7 Active advanced programming menu (SET)

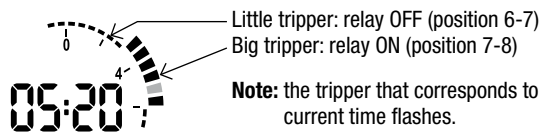

5 INSTALLATION

- The instrument provides with the inserted battery and the set date
 - Connect the load and the power supply as illustrated in section "Connection diagram". The backlight will turn on as soon as the instrument is powered and remains always on (in the presence of mains power).
 - For operating, the installation location must be set:
 - press any key: the instrument requires you to set the location (for Italy only the telephone area code, for the other states the geographic coordinates are required)
 - when the installation position is set, the instrument is able to calculate automatically the sunrise and sunset time for each day during the year. The instrument will turn on the load at the sunset and turn off it at the sunrise.
- Note:** if any position isn't set, all the internal trippers will flashing and the relay will remain off.

REFERENCE STANDARDS

Compliance with Community directives:
2014/35/EU (LVD), 2014/30/EU (E.M.C.D.)
is declared in reference to the following harmonised standards:
• EN 60730-2-7

1 User manual

ASTRONOMICAL TWILIGHT SWITCHES WITH TRIPPERS

Read all instructions carefully

Simply AST is an astronomical twilight switch used to manage electric utilities between sunset and sunrise which are automatically calculated by the instrument based on the geographical coordinates inserted (for Italy only the telephone area code).
The trippers permit you to set one or more intervals in which the load turn off. The cover on the back of the instrument allows battery replacement once depleted.
Simply AST is an electronic device that performs 1BTU type actions designed for use in place with over-voltage category III and pollution degree 2, as per standards EN 60730-1.

Code	Model	Description
VE707600	Simply AST	Astronomical twilight switches with trippers

SAFETY WARNINGS

During product installation and operation it is necessary to observe the following instructions:

- 1) The instrument must be installed by a qualified person, in strict compliance with the connection diagrams.
- 2) Do not power the product if any part of it is damaged.
- 3) The instrument must be installed and activated in compliance with current electric system standards.
- 4) The electrical system in the building in which the instrument is to be installed should have an over-current switch and a protection device.
- 5) Before accessing the connection terminals, verify that the leads are not live.
- 6) After installation, inaccessibility to the connection terminals without appropriate tools must be guaranteed.
- 7) In case of malfunction do not perform repairs and contact immediately the technical support.

TECHNICAL CHARACTERISTICS

- Power supply: 230 Vac (-15% ÷ +10%) 50/60 Hz
- Absorption: 6 VA (1W)
- Output: relay with change-over monostable contact from 16 A / 250 Vac
- Minimum interval for turning-off in the night: 30 minutes
- Summer/winter time automatic update (removable) depending on the geographical zone of installation
- Active backlight display with mains power
- Replaceable CR2032 type backup battery (duration: 5 years about)
- Operating temperature: -20 ÷ +50 °C
- Storage temperature: -25 ÷ +70 °C
- Operating humidity: 20÷90% non condensing
- Container: 2 DIN modules
- Degree of protection: IP20
- Actions type: 1BTU
- Insulation: reinforced among accessible parts (frontal) and all other terminals

6 PROGRAMMING

Simply AST programming consists of a single program to be repeated every day, according to which the output is in the ON position between the time of sunset and the time of sunrise and in the OFF position between sunrise and sunset.



Between sunset and sunrise it is possible to set one or more intervals with minimum duration of 30 minutes in which the output relay will be off.

1. from the main page press **PROG** key.
2. the programming starts from the first tripper into the interval between sunset and sunrise
3. press the key **▲** or **▼** to set the tripper (**▲** = relay on, **▼** = relay off) and press **PROG** to confirm and step up of 30 minutes (the next tripper)
4. once the desired programming is got, press **PROG** key for at least 3 seconds to exit and return to the main page.

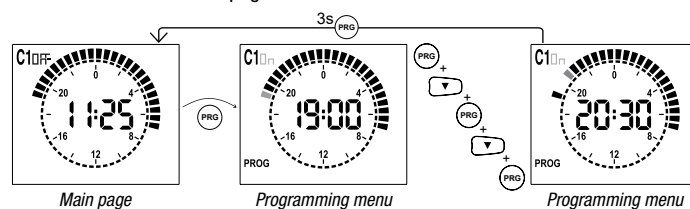

7 ADVANCED PROGRAMMING

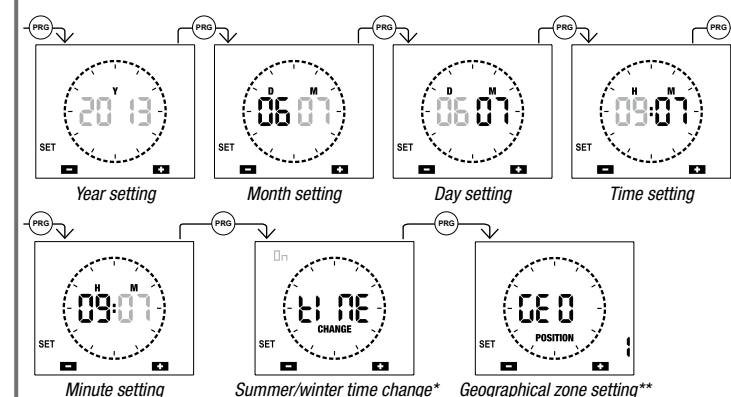
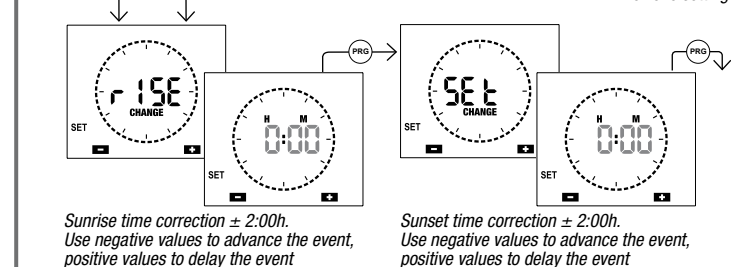
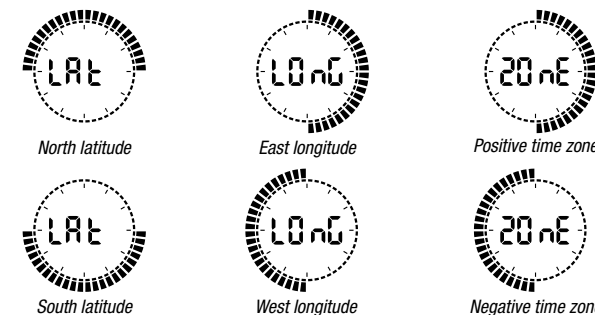
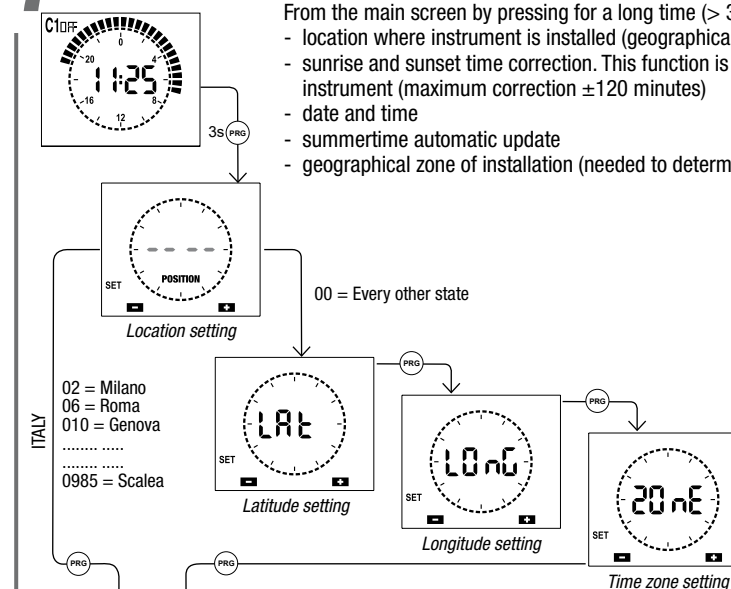

(*) summer/winter time change
If the automatic update of summer time is active (on), the change occurs according to the set geographical zone:

Zone	Start DST (+1h)	End DST (-1h)
01 Europe	Last Sunday, March	Last Sunday, October
02 North America	Second Sunday, March	First Sunday, November
03 Australia	First Sunday, October	First Sunday, April
04 Chile	Second Sunday, October	Second Sunday, March
05 New Zealand	Last Sunday, September	First Sunday, April

Note: time change is fixed for all zones at 2:00 o'clock for the start of DST and at 3:00 o'clock for the end of DST.

(**) If the instrument is installed in Italy, geographical zone setting are not required.

Note: activation and deactivation of the load occur exactly at the sunset and sunrise time; the trippers containing those times are ON (big trippers).
Note: you can exit programming even if you don't press any key within the time-out (40 seconds if the instrument is mains powered, 10 seconds if powered by the backup battery). The modifications are still saved.

Display date, sunrise and sunset time
From the main page, by pressing the key **▲** it's possible to display the current date and the sunrise and sunset time.
Before each parameter an identification abbreviation is displayed (dRtE for date, r 1SE for sunrise and SEt for sunset).
At the end the instrument return to the main page.

8 RELAY MANUAL SWITCHING

To change manually the status of relay output (from ON to OFF or vice versa) press the **▼** key.
Attention: the status is maintained until new press of the **▼** key or until the next program switching.
To lock the current status of the relay and prevent its switchings, press for a long time (> 3 seconds) the key **▼**. In this condition the symbol **🔒** is lit.
Unlocking is done by pressing for a long time the **▼** key.

9 DEPLETED BATTERY

When the backup battery is low, the instrument displays bRtE alternating with the main page. In this condition, replace the battery as soon as possible, by accessing the battery compartment at the back of the instrument, to avoid that, in case of blackout, the date and time are lost.
In this condition, when mains power return, display will flash, the time start from 00:00 of 01.01.2014 and the relay stays in OFF position.
In this case, to resume the normal operating, set time and date.
Dispose of used batteries in accordance with the current legal provisions regarding the disposal of hazardous waste.
Attention: before you access the battery compartment, disconnect the power supply.
Attention: perform the operation in a maximum time of one minute in order not to lose date and time. Use only CR-2032 type battery.

10 DEFAULT PARAMETERS

The default of the parameters shows the instrument factory conditions, that is to say

- position: none
- geographical zone: 1 (Europe)
- winter time automatic change: active
- programming: ON at sunset, OFF at sunrise
- sunrise and sunset time adjust: 0

To perform the default, from the main screen press simultaneously for at least 3 seconds the keys **▲**, **PROG** and **▼** and, during dEF flashing, confirm by pressing **PROG** key.
Attention: if during dEF flashing you don't press any key within 5 seconds, the instrument returns to the main screen without perform the reset.
Note: after default, all the internal trippers will flash. Press any key to set the location (see box 5 – Installation).

information to users pursuant to art. 14 of the directive 2012/19 / EU of the european parliament and of the council of 4 July 2012 on waste electrical and electronic equipment (WEEE)

If the crossed-out bin symbol appears on the equipment or packaging, this means the product must not be included with other general waste at the end of its working life.

The user must take the worn product to a sorted waste center, or return it to the retailer when purchasing a new one.
Products for disposal can be consigned free of charge (without any new purchase obligation) to retailers with a sales area of at least 400 m², if they measure less than 25 cm.
An efficient sorted waste collection for the environmentally friendly disposal of the used device, or its subsequent recycling, helps avoid the potential negative effects on the environment and people's health, and encourages the re-use and/or recycling of the construction materials.