



# Mod. THALOS KEY

Manuals download



Vemer S.p.A.  
I - 32032 Feltre (BL) • Via Camp Lonc, 16  
e-mail: info@vemer.it - web site: www.vemer.it

## 2 DIMENSIONS

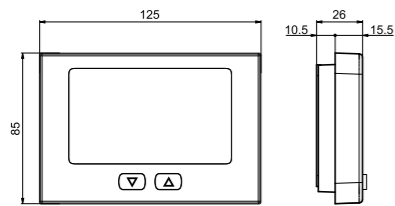

## 3 WIRING DIAGRAMS

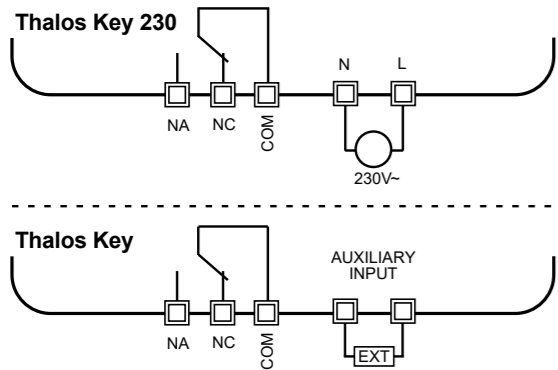

## 4 LEGEND

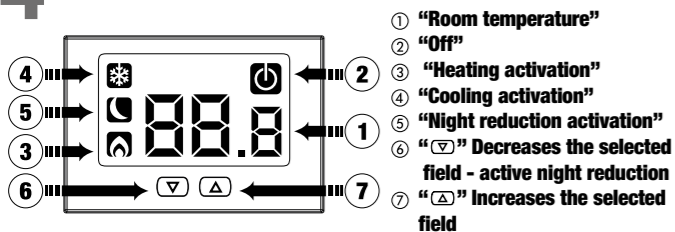

## 5 INSTALLATION

- Thalos Key series thermostats are designed for wall mounting installation. Alternatively, they can be installed to cover the in-built three-modules box.
- Install the thermostat at a height of about 1.5 m above the floor, away from direct sunlight, away from doors, windows, heat sources, locations with excess or total lack of ventilation.

- Connect the wires to the terminals block on back of the base, as shown in the "wiring diagrams".
- Fix the base on the wall using the screws supplied.

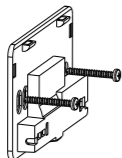
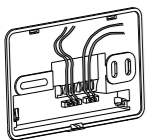

- For battery-powered models only: insert the batteries into the battery compartment on the back of the thermostat, respecting the indicated polarity.

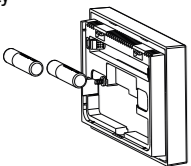

- Attach the thermostat to the base, at first mating teeth on the higher side.

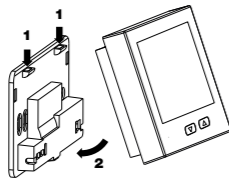

# 1 User manual

## WALL-MOUNTING ELECTRONIC THERMOSTATS

⚠ Read all instructions carefully

Series of wall mounting electronic thermostats for temperature control both in heating and cooling. They perform actions of type 1B and are intended for operating in rooms with Pollution Degree 2 and Overvoltage Category III (EN60730-1).

- Thalos Key battery powered has an auxiliary input for a temperature probe configuration or of an external contact to reduce setpoint of 3 °C.
- Thalos Key 230 AC-powered.

Code	Model	Description
VE718300	Thalos Key Bianco	Battery Thermostat with auxiliary input
VE719100	Thalos Key Nero	Battery Thermostat with auxiliary input
VE720900	Thalos Key 230 Bianco	230V Thermostat
VE721700	Thalos Key 230 Nero	230V Thermostat

### SAFETY WARNINGS

During product installation and operation it is necessary to observe the following instructions:

- The instrument must be installed by a qualified person, in strict compliance with the connection diagrams.
- Do not power or connect the instrument if any part appears to be damaged.
- After installation, inaccessibility to the connection terminals without appropriate tools must be guaranteed.
- The instrument must be installed and activated in compliance with current electric systems standards.
- Before accessing the connection terminals, verify that the leads are not live.
- In the electrical system of the building where the instrument must be installed, a switch and a protection device from the overcurrents must be present (for Thalos Key 230 models only).

### TECHNICAL SPECIFICATIONS

- Power supply Thalos Key:
  - 2 alkaline batteries 1.5V (AAA type)
  - battery life: 12 months
  - low battery indication
- Power supply Thalos Key 230:
  - 230Vac (-15% ÷ +10%) 50/60Hz
  - max absorption: 6 VA / 230Vac
- Wall mounting or to coverage the in-built three-modules box
- Terminals Thalos Key:
  - 3 terminals for 1.5 mm<sup>2</sup> cable section for bistable output relay 5A / 250 Vac
  - 2 terminals for 1.5 mm<sup>2</sup> cable section for auxiliary input (to connect a temperature probe or an external contact to reduce setpoint of 3°C)
- Terminals Thalos Key 230:
  - 3 terminals for 1.5 mm<sup>2</sup> cable section for monostable output relay 5A / 250 Vac
  - 2 terminals for 1.5 mm<sup>2</sup> cable section for power supply
- Operating mode: summer/winter/off (with antifreeze operating mode)
- Password protected lock keypad
- Type of command:
  - on/off with settable differential (0.1 ÷ 1 °C)
  - P8 proportional with 0.8 °C band (-0.3 ÷ +0.5 °C) and period 8 minutes
  - P15 proportional with 1.5 °C band (-0.7 ÷ +0.8 °C) and period 15 minutes
- Measurement precision: ±0.5 °C
- Measurement temperature resolution: 0.1 °C
- Settable setpoint range: 2 °C ÷ 50 °C
- Operating temperature: 0 °C ÷ +50 °C
- Storage temperature: -10 °C ÷ +65 °C
- Operating humidity: 20÷90% non condensing
- Degree of protection: IP40
- Insulation: reinforced among accessible parts (frontal) and all other terminals

Information to users pursuant to art. 14 of the directive 2012/19 / EU of the european parliament and of the council of 4 July 2012 on waste electrical and electronic equipment (WEEE)



If the crossed-out bin symbol appears on the equipment or packaging, this means the product must not be included with other general waste at the end of its working life.

The user must take the worn product to a sorted waste center, or return it to the retailer when purchasing a new one.

Products for disposal can be consigned free of charge (without any new purchase obligation) to retailers with a sales area of at least 400 m<sup>2</sup>, if they measure less than 25 cm.

An efficient sorted waste collection for the environmentally friendly disposal of the used device, or its subsequent recycling, helps avoid the potential negative effects on the environment and people's health, and encourages the re-use and/or recycling of the construction materials.

# 6 OPERATION

During normal operation the thermostat displays the measured temperature value and the relay status is identified by the symbol (heating) or by the symbol (cooling).

### Setpoint modification

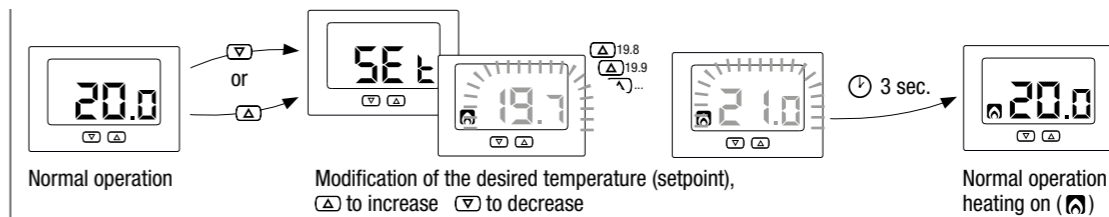

### Depleted batteries signal

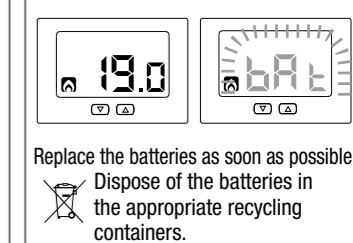

### Switch off

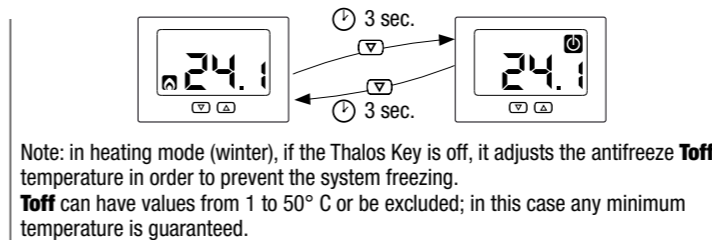

### Error messages

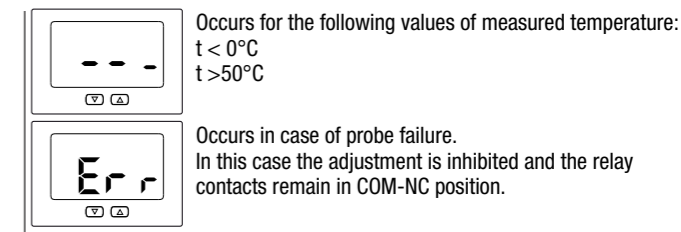

### Reset

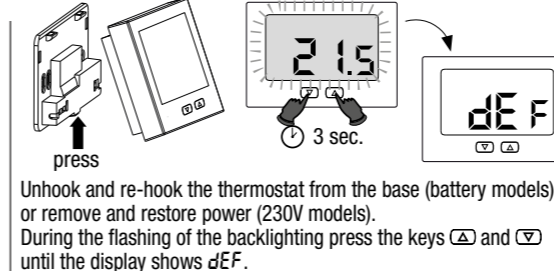

### Default values

Heating setpoint	21 °C
Cooling setpoint	25 °C
Minimum settable setpoint - L	2 °C
Maximum settable setpoint - H	50 °C
Operating mode	(heating)
Antifreeze temperature	6 °C
Type of command	On /Off
Differential	0.3 °C
Auxiliary input	DIG
Password	--- (disabled)

### Night reduction

(only battery models)

"Night reduction" function reduces the programmed setpoint by 3 °C. Press for 3 seconds the key to activate (or deactivate, if already active) the night reduction. When the night reduction is active, the display shows the symbol .

### Advanced programming

To enter menu Advanced programming keep simultaneously pressed for 5 seconds the keys and until Pr will appear. The items of the menu are displayed in succession. For each item is displayed an identity breviation and its relative blinking value. Use the keys and to modify the value. The passage to the next parameter occurs after 3 seconds without pressing any key. The writing Err will appear when all parameters are set and the thermostat returns to normal operation saving the effected modifications.

- LO** Minimum settable setpoint - L It's the minimum value settable as setpoint. Settable values: 2 ÷ 50 °C
- H I** Maximum settable setpoint - H It's the maximum value settable as setpoint. Settable values: L ÷ 50 °C
- E - 1** Operating mode - E - 1 if connected to the boiler (heating) if connected to a cooling system
- 06.0** Antifreeze temperature - Toff Minimum temperature maintained with Thalos Key off (see box «Switch off»). Settable values: 1 ÷ 50 °C or --- (excluded function)
- r E 0** Type of command - r E 0 - (only in heating) = on/off with settable differential = proportional with band 0.8 °C and period 8 minutes = proportional with band 1.5 °C and period 15 minutes
- d 0.3** Differential - d - (only for on/off regulation) Differential (or hysteresis) for temperature regulation. Settable values: 0.1 ÷ 1 °C
- ES t** Input configuration - Est - (only battery models) - for one temperature probe connection - for an external contact connection to reduce setpoint (see box "Auxiliary input configuration")
- PR 5** Password for keypad lock - PR 5 Set a value between 001 and 999 to activate the keypad lock. Set "---" to disable the lock. If the keypad lock is active, pressing one key appears and the password is required. If it's properly inserted the keyboard is unlocked for the next 30 seconds.

### Auxiliary input configuration (only battery models)

Models battery powered have a auxiliary input that can be configured for connection instead of:  
- an external temperature probe  
- an external contact for the set-point temperature reduction. Closed external contact allows setpoint reduction of 3 °C than the set one. Display shows the symbol .

For auxiliary input configuration, see "Advanced programming" on this manual.

### Backlighting management

- Battery models** In the battery-powered supplied models the display backlighting is normally OFF and it is enabled (blue colour) entering menu: setpoint modification, advanced programming, pin enter.
- Models 230V** In the 230Vac power supplied models the display backlighting is normally ON.
- Backlighting switching OFF** If not desired the backlighting function can be disabled (for example in bedrooms). Then the thermostat continues its normal operation and the backlighting is enabled entering menu: setpoint modification, advanced programming, pin enter.

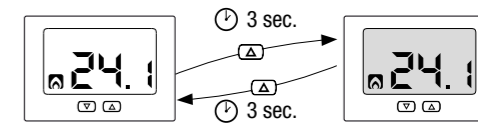

### REFERENCE STANDARDS

Compliance with Community Directives:  
2014/35/UE (LVD)  
2014/30/UE (EMCD)  
is declared in reference to the harmonized standard:  
• EN 60730-2-9