

**INTERRUTTORE
ORARIO/ASTRONOMICO DIGITALE**

Manuale d'Uso

memo BT

Digital time/astronomical switch: User Manual



Vemer
SPA



Index

■ Technical features	page	3		
■ Safety warnings	page	4		
■ Dimensions	page	4		
■ Wiring diagrams	page	5		
■ Display and keyboard description	page	6		
■ Initial operation	page	7		
■ Start page (or main)	page	8		
■ Menu description	page	11		
■ Settings menu	page	12		
Language setting menu	page	13		
Date setting menu	page	14		
Time setting menu	page	15		
Daylight saving time (DST)/winter time (CET) change setting menu	page	16		
Astronomical coordinates setting menu	page	18		
Random switchings setting menu	page	20		
Protection PIN setting menu	page	21		
■ Program menu	page	22		
Program menu: new	page	27		
Program menu: new daily timed	page	28		
Program menu: new weekly timed	page	29		
Program menu: new yearly timed	page	30		
Program menu: new holiday timed	page	32		
Program menu: new astro night	page	34		
Program menu: new astro daily	page	38		
Program menu: new astro weekly	page	39		
Program menu: new astro yearly	page	40		
Program menu: new astro holiday	page	42		
Program menu: check	page	44		
Program menu: modify	page	46		
Program menu: copy	page	48		
Program menu: delete	page	49		
■ Bluetooth menu	page	50		
■ Hour couter menu	page	52		
■ Reset menu	page	54		
■ Firmware menu	page	56		
■ Error signals	page	57		
■ Battery management	page	58		
■ Reference standards	page	58		

USER MANUAL

The digital time switches of memo BT series are electronic devices for the management of the electrical utilities with a programming of time or astronomical type.

They have one (memo BT1 and memo BT Y1) or two (memo BT2 and memo BT Y2) independent relays (channels). In the 2-channel models the relays can be configured with a different programming (timed or astronomical).

The bluetooth interface allows it to be coupled with mobile devices (smartphone or tablet). Thanks to the free app that can be downloaded from the AppStore and Google Play stores, it is possible to program and make settings directly on your smartphone, and then transfer all the data to the time switch.

The reverse procedure is also possible, i.e. to copy the programming of a time switch on your mobile device.

The backup battery allows you to keep the settings even in case of black-out and can be replaced through the cover on the back of the time switch.

The switches of memo series perform actions of 1BTU type and are intended to operate in environments with III overvoltage category and pollution degree 2 in accordance with EN 60730-1 standard.

Code	Model	Description	Power supply
VE767600	memo BT1	Daily/weekly/astronomical/time switch with 1 relay and Bluetooth interface	230 V AC
VE767601	memo BT1	Daily/weekly/astronomical/time switch with 1 relay and Bluetooth interface	115 V AC
VE767700	memo BT2	Daily/weekly/astronomical/time switch with 2 relays and Bluetooth interface	230 V AC
VE767701	memo BT2	Daily/weekly/astronomical/time switch with 2 relays and Bluetooth interface	115 V AC
VE788400	memo BT Y1	Daily/weekly/yearly/astronomical time switch with 1 relay and Bluetooth interface	230 V AC
VE788500	memo BT Y2	Daily/weekly/yearly/astronomical time switch with 2 relays and Bluetooth interface	230 V AC

TECHNICAL FEATURES

- Power supply:
 - 230 Vac (-15% ÷ +10%) 50/60 Hz
 - 115 Vac (-15% ÷ +10%) 50/60 Hz(depending on the model, see page 2)
- Power consumption:
 - memo BT1 and memo BT Y1: 1 W (3.5 VA)
 - memo BT2 and memo BT Y2: 1.5 W (5.5 VA)
- Lithium backup battery: 3 V, CR2032 type (replaceable)
- Output:
 - type: monostable relay with changeover contacts and maximum switchable load of 16 A / 250 V
 - number of relays: 1 (memo BT1 and memo BT Y1),
2 (memo BT2 and memo BT Y2)
- Terminal block for cables with maximum cables section of 2.5 mm²
- Display LCD with backlighting (active with AC power supply)
- Bluetooth BLE 4.1 communication interface (active with mains power supply)
- Storable programs:
 - memo BT1 and memo BT Y1: 120 events
 - memo BT2 and memo BT Y2: 120 events that can be shared on the 2 channels
- Actions type: 1BTU
- Operating temperature: -20 °C ÷ 50°C
- Operating humidity: 20 ÷ 90% non condensing
- Storage temperature: -25°C ÷ 70°C
- Operating frequency band: 2400-2483.5 MHz
- Maximum transmitted radiofrequency power: 4 dBm
- Container: 2 DIN modules
- Protection degree: IP20
- Insulation: reinforced between accessible parts (front) and all the other terminals

SAFETY WARNINGS

■ **During product installation and operation it is necessary to observe the following instructions:**

- 1) The product must be installed by a qualified person, strictly in observance of the connection diagrams shown in this manual.**
- 2) After installation inaccessibility to the terminals without using dedicated tools must be guaranteed.**
- 3) Before accessing the connection terminals, make sure that the leads are not live.**
- 4) Do not connect or feed the product if any part of it is damaged.**
- 5) The product must be installed and activated in compliance with current electric systems standards.**
- 6) Do not use the product for anything other than the indicated purpose.**
- 7) In the electrical system upstream of the product must be installed a protection device against the overcurrents**
- 8) The product can be used in environments with Measurement Category III and Pollution degree 2, according to the Standard EN 60730-1**

DIMENSIONS

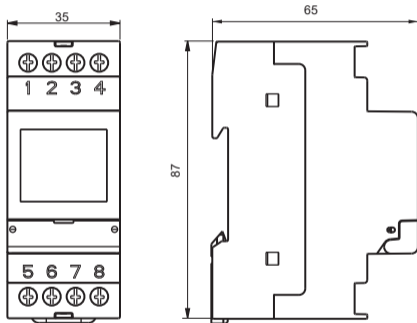

WIRING DIAGRAMS

memo BT1 and memo BT Y1

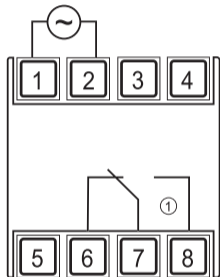

memo BT2 and memo BT Y2

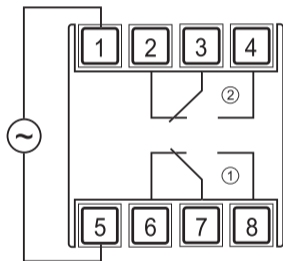

DISPLAY AND KEYBOARD DESCRIPTION

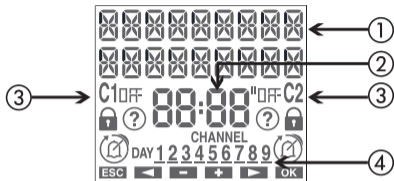

- ① General indications
- ② Time indication
- ③ Channel 1/channel 2 status indication
 - _n / OFF channel status
 - 🔒 blocked switchings
 - ⊙ active random switchings
 - ↗ active holiday program
 - ⏰ active pulse program
 - 🕒 active manual program
- ④ Day of the week (DAY) indication

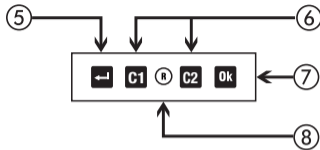

- ⑤ Menu activation/output (1 level back)
- ⑥ Key **"C1"**: decreases datum/previous menu/ switching channel 1/lock channel 1
Key **"C2"**: increases datum/next menu/ switching channel 2/lock channel 2
- ⑦ Confirm selection
- ⑧ Hardware reset

Key **"OK"** + **"C1"** (3 sec): random switching channel 1

Key **"OK"** + **"C2"** (3 sec): random switching channel 2

INITIAL OPERATION

- Once out of the package, memo BT is off: press the key **⏏** and wait a moment before activating the display
- The set language is Italian. To change it, press the key **⏏** for at least 3 seconds. Choose among: Italian, English, Spanish, French or German and confirm with **Ok**
- Make connections following the diagrams on page 5 of this manual
- Power memo BT: the backlighting turns on permanently.
- The presence of the backup battery allows the memo BT to have updated date and time.

To make the other settings follow the following steps:

Date	- format: DD/MM/YY - 1 st day of the week: Monday
Astronomical coordinates	- country: Italy - city: Agrigento - latitude: North (37° 19' 12") - longitude: East (13° 34' 12")

Daylight Saving time (DST) - start of daylight saving time (DST):	change: active	last Sunday of March at 02:00 o'clock
- end of daylight saving time (DST):		last Sunday of October at 03:00 o'clock

Time correction:	- sunrise: +0:00 - sunset: +0:00
------------------	-------------------------------------

Time zone:	+1:00 UTC
------------	-----------

Random switchings:	- minimum: 1 minute - maximum: 5 minutes
--------------------	---

PIN protection:	disabled (---)
-----------------	----------------

Bluetooth:	active
------------	--------

Bluetooth password:	123456
---------------------	--------

START PAGE (or main)

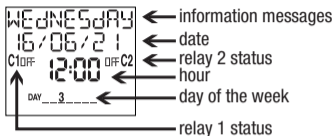

Information messages

- day of the week
- product identification code and serial number
- battery status (only if discharged)
- NO SUPPLY*

* Only if memo BT is not powered by mains.
In this condition the backlighting is not active and the relay is in off status.

NOTE: Bluetooth interface is active only when memo BT displays the start page (main) and only if it's mains power supplied. Therefore, to transfer programs from and to the time witch it is necessary to respect these conditions.

Manual relay 1 switchings

- Key "**G1**": ON/OFF manual relay switching.
When manual switchings are active, on the display the symbol ☺ is on
This condition persists until the achievement of the subsequent programmed switching.
- Key "**G1**" (3 sec) blocking (or unblocking) of relay switchings.
When the switchings are blocked, the display shows the symbol 🚫 on.
- Key "**Ok**" + "**G1**" (3 sec): activation (or deactivation) of random relay switching. When the random switchings are active, the display shows the symbol 🎲 on.

Manual relay 2 switchings (only for memo BT2 and memo BT Y2)

- Key "**C2**": ON/OFF manual relay switching.
When manual switchings are active, on the display the symbol ☺ is on
This condition persists until the achievement of the subsequent programmed switching.
- Key "**C2**" (3 sec) blocking (or unblocking) of relay switchings.
When the switchings are blocked, the display shows the symbol 🚫 on.
- Key "**Ok**" + "**C2**" (3 sec): activation (or deactivation) of random relay switchings. When the random switchings are active, the display shows the symbol 🎲 on.

Access the store of your device, install and start the free app memo – Vemer.

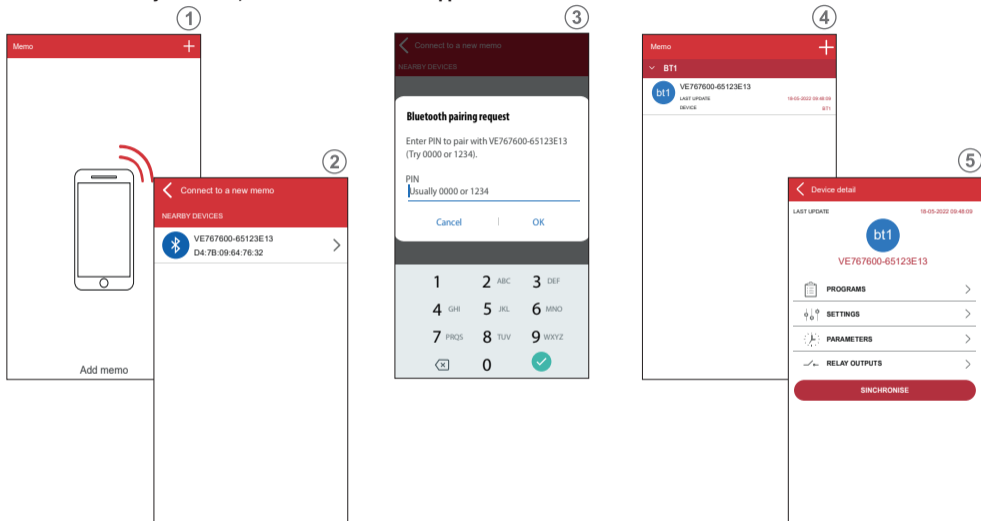

- ① At the start the app displays the list of the associated memo BT devices. To associate a new device, press the symbol “+” in the upper right corner.
- ② All the Bluetooth devices detected nearby are displayed: select the device to be associated from the list.
Note: each device is identified by the product code (for example VE767600) and by the serial number (for example 00000020).
These informations can be viewed from the main page of the memo BT
Warning: make sure that the memo BT is mains powered and that the display shows the main page (initial).
Otherwise the Bluetooth interface is not active and the device is not visible
- ③ Enter the password to associate the memo BT with your device (if not modified the password is 123456)
- ④ After successfully completing the procedure, the memo BT is added in the list of the associated devices.
Select the memo BT on which you want to act from the list of the associated devices
Note: communication between the app and the memo BT is point-to-point. This means that, even in the presence of multiple memo BT, the app can communicate with one only at a time.
The memo BT currently connected to the app displays the symbol * immediately after the serial number
- ⑤ The app displays the initial page of the selected memo BT. From this page you can:
 - a. Create new programs that will then be copied to the memo BT
 - b. Change the settings of the memo BT
 - c. View the parameters and associate an alias (name that identifies the time switch, such as “memo BT1 Belluno”) to the memo BT
 - d. Manually control the relay output/s and activate the random switching function

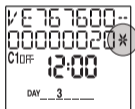

MENU DESCRIPTION

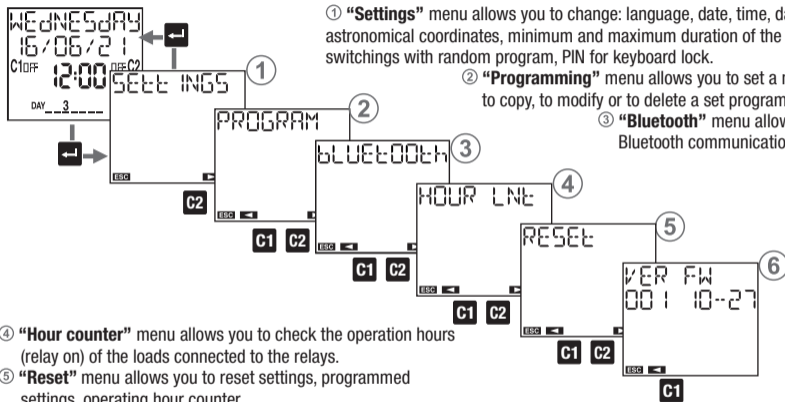

① **“Settings”** menu allows you to change: language, date, time, daylight saving time (DST), astronomical coordinates, minimum and maximum duration of the interval between two switchings with random program, PIN for keyboard lock.

② **“Programming”** menu allows you to set a new program or to check, to copy, to modify or to delete a set program.

③ **“Bluetooth”** menu allows you to configure the Bluetooth communication interface.

④ **“Hour counter”** menu allows you to check the operation hours (relay on) of the loads connected to the relays.

⑤ **“Reset”** menu allows you to reset settings, programmed settings, operating hour counter.

⑥ **“Ver FW”** menu allows you to check the firmware version installed on the device.

SETTINGS MENU

“Settings” menu allows you to view and eventually to modify the general operation settings of memo BT, such as:

- ① language
- ② date
- ③ time
- ④ automatic daylight saving time (DST) change
- ⑤ position (astronomical coordinates)
- ⑥ interval duration between two random switchings
- ⑦ keys protection by PIN

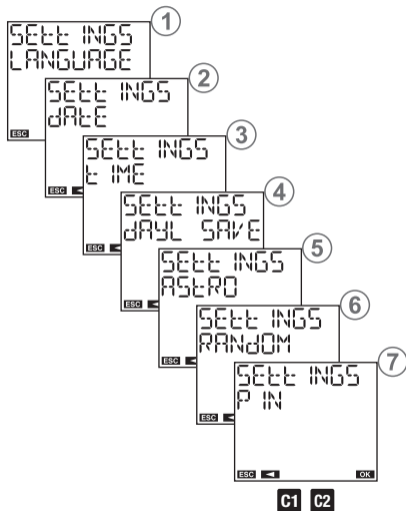

Language setting menu

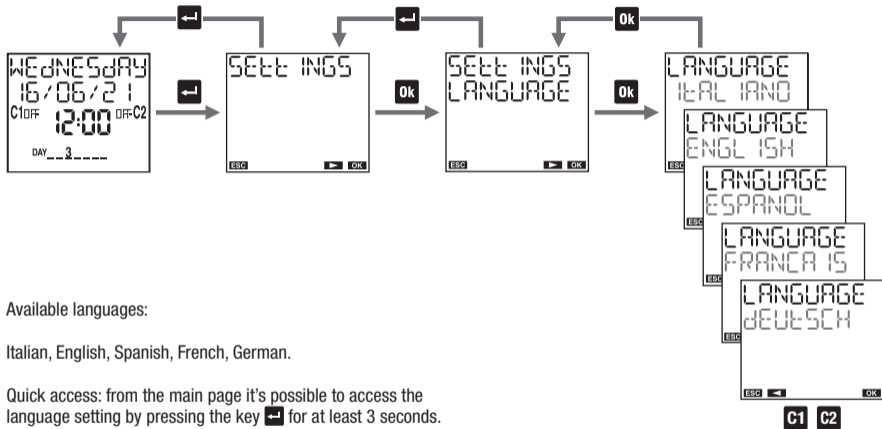

Available languages:

Italian, English, Spanish, French, German.

Quick access: from the main page it's possible to access the language setting by pressing the key **Left Arrow** for at least 3 seconds.

Date setting menu

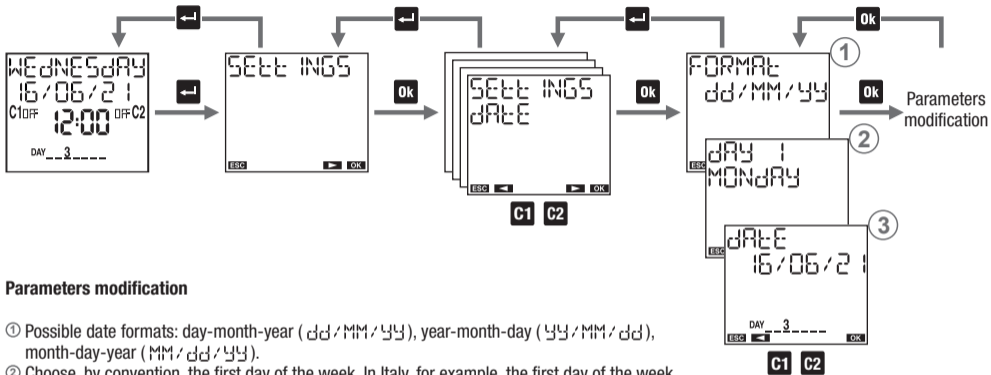

Parameters modification

- ① Possible date formats: day-month-year (dd/MM/yy), year-month-day (yy/MM/dd), month-day-year (MM/dd/yy).
- ② Choose, by convention, the first day of the week. In Italy, for example, the first day of the week is Monday, in the UK it's Sunday.
- ③ Enter the date: day, month, year.

Time setting menu

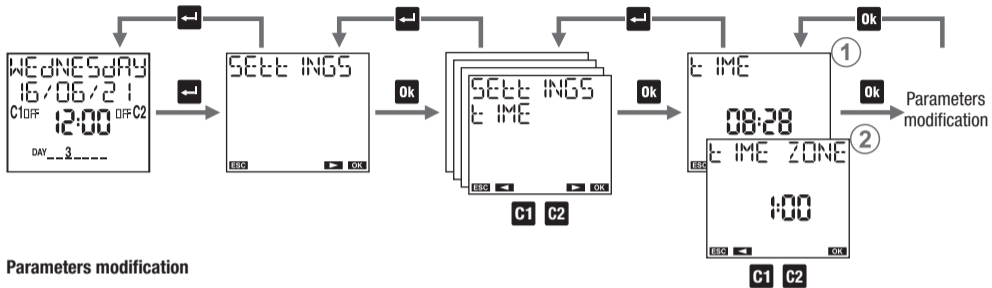

Parameters modification

- ① Set the time: hours, minutes.
- ② Set the time zone. Range: -14:00 ÷ +14:00 at 15 minutes steps.
For Italy set +1:00.

Daylight saving time (DST)/winter time (CET) change setting menu

Daylight saving time (DST) / winter time (CET) change and vice versa can occur in an automatic way. In this case, memo BT:

- increases by an hour in the passage from winter time (CET) to daylight saving time (DST)
- decreases by an hour in the passage from daylight saving time (DST) to winter time (CET)

For every change it's necessary to specify:



the week of the month during
which the time change occurs
(first, second, third, fourth, last)



the day of the week
(Monday: 1, Tuesday: 2, ...)



the month



the hour and the minutes

In Italy, for example, daylight saving time (DST) begins the last (LAST) Sunday (7) of March (03) at 02:00 o'clock and ends the last (LAST) Sunday (7) of October (10) at 03:00 o'clock.

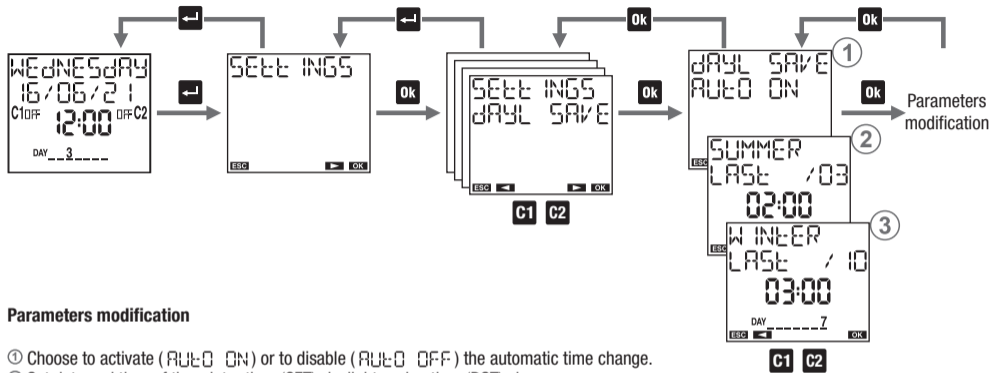

Parameters modification

- ① Choose to activate (AUTO ON) or to disable (AUTO OFF) the automatic time change.
- ② Set date and time of the winter time (CET)-daylight saving time (DST) change.
- ③ Set date and time of the daylight saving time (DST)-winter time (CET) change.

Astronomical coordinates setting menu

The setting of the geographical coordinates of the installation place allows memo BT to calculate, for each day of the year, sunrise and sunset times. To simplify the procedure, in the memo BT are stored the coordinates of the locations listed below; if your location is among them you can select it from the menu ①, otherwise it's necessary to enter the coordinates of latitude and longitude (menu ② ③).

Note: if the display at point ① shows "-----" it means that the latitude and longitude coordinates have been entered.

Stored location: **Italy**: all provinces. **United Kingdom**: Cardiff, Belfast, Edinburgh, London. **Spain**: Barcelona, Madrid, Seville, Valencia
France: Lyon, Marseille, Paris, Toulouse. **Germany**: Berlin, Hamburg, Cologne, Monaco

The correction of sunrise and sunset times is useful for applications that require the turning on of lights in particular localities. It's possible, in fact, that the presence of disturbing elements, such as the mountains, can influence actual times of sunrise and sunset, making it necessary to advance or delay of a few minutes the calculated times.

The twilight is the time interval before sunrise, or after sunset, characterized by the permanence of the light due to the spread by the atmosphere of the Sun light. During these time intervals it's possible to distinguish clearly objects and conduct outdoor activities without using additional lighting. Therefore, in some applications it is more interesting to take as times of switching on and off the twilight (civil) in place of sunrise and sunset. With memo BT it's possible to choose to turn on/off the loads depending on the times of sunrise and sunset or the civil twilight. The calculated time correction also applies to the times of twilight.

To view the calculated switching on time (sunset) and switching off time (sunrise), from the main screen press the key **OK**.

The times displayed take into account any corrections entered.

If the display shows $\overline{\overline{\square}}$ it means that the calculated sunrise time is after the sunset time. If the display shows $\underline{\underline{\square}}$ it means that the calculated sunrise time is before 00:00 or that the calculated sunset time is after 23:59.

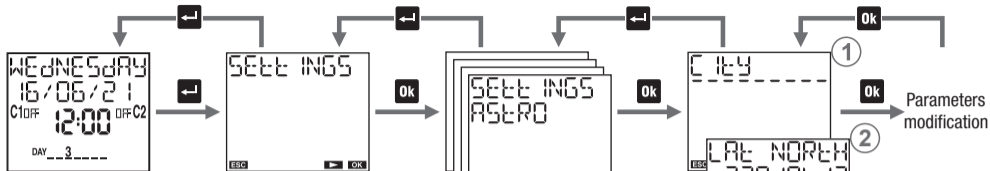

Parameters modification

- ① Choose the installation location. If it's not present, proceed with steps ② and ③.
- ② Set the latitude of installation place.
- ③ Set the longitude of installation location.
- ④ Set a possible correction of the calculated sunrise time. Positive values to delay, negative values to anticipate.
- ⑤ Set a possible correction of the calculated sunset time. Positive values to delay, negative values to anticipate.
- ⑥ Choose as switching times the civil twilight (C 14 IL S) in place of sunrise and sunset (C 14 IL N) times.

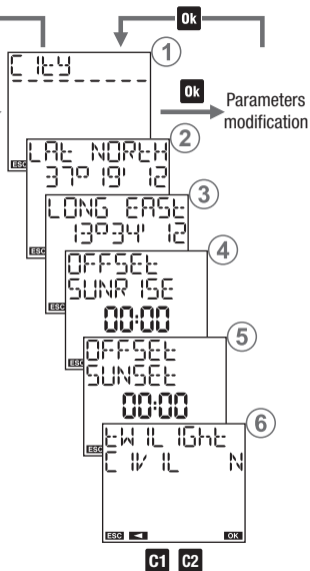

Random switchings setting menu

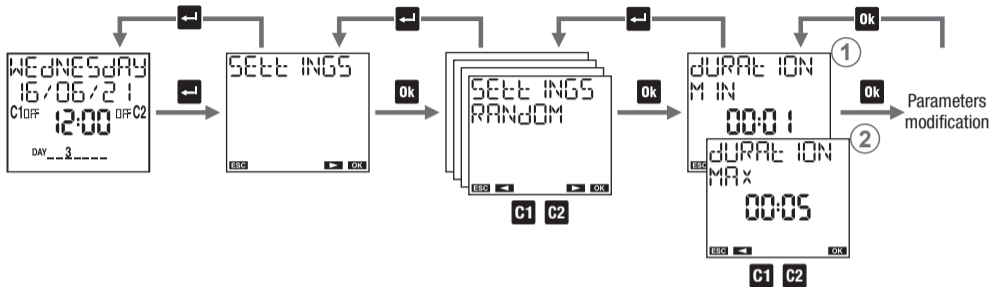

The “random switching ②” function (activated with the combination described on page 6) allows the channel on which it’s active to automatically switch and at random time intervals.

In this menu it’s possible to define the minimum and maximum duration of the time interval between two random switchings. Default minimum duration is 1 minute, maximum duration is 5 minutes.

Parameters modification

- ① Set the minimum duration. It’s possible to set values between 1 minute and the *maximum duration*.
 - ② Set the maximum duration. It’s possible to set values between the *minimum duration* and 23:59 hours.
- Note: setting the minimum duration equal to the maximum, the switchings will occur at fixed time intervals.

Protection PIN setting menu

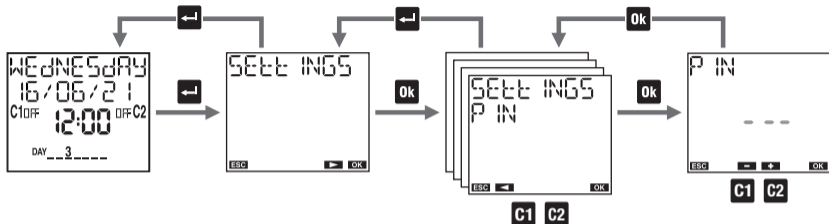

The protection code (PIN) is used to lock the keyboard and prevent changes by unauthorized persons. With active PIN protection, pressing any key, it's necessary to enter the PIN: if PIN is correct the keyboard unlocks; after 3 minutes without pressing a key, the keyboard will lock automatically.

To activate PIN protection:

- set a value between 000 and 999

To disable PIN protection:

- set "---" (located before 000 or after 999)

Note: If you have forgotten your PIN code to unlock memo BT it's necessary to carry out a hardware reset (see page 54).

PROGRAM MENU

The menu “program” allows you to:

- ① create a new program
- ② check created programs
- ③ change or delete a created program
- ④ copy all created programs of channel 1 on channel 2 and vice versa (only for memo BT2 and memo BT Y2)
- ⑤ delete all programs of a channel

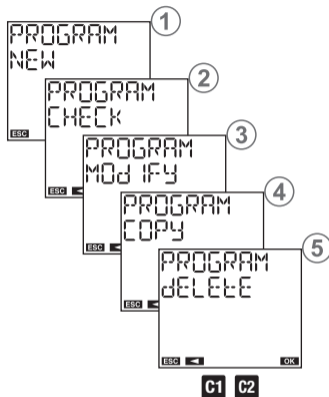

Select days

scroll through the days of the week from 1 to 7:

- by pressing the key **C2** to move to the next day without selecting the current day
- by pressing the key **Ok** to select/deselect the current day and move to the next

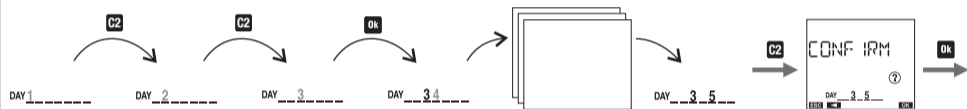

Programs types

- Program ON/OFF: is composed of a switching of the ON relay and of a subsequent switching of the OFF relay. It can have a daily period (everyday with the same modes), weekly (every week with the same modes) or yearly (every year with the same modes).
- PULSE ON program: is an ON relay switching for a maximum duration of 59 seconds. It can have a daily period (everyday with the same modes), weekly (every week with the same modes) or yearly (every year with the same modes).
- PULSE OFF program: is a relay switching OFF for a maximum duration of 59 seconds. It can have daily period (everyday with the same modes), weekly (every week with the same modes) or yearly (every year with the same modes).
- HOLIDAY program: is a period of time defined by a start time and an end time within which all programmed switchings (of that channel) are disabled. The relay is in OFF position (OFF holiday) or in ON position (ON holiday).

Channel types

- TIME channel. Carries out programs of time type: ON / OFF, ON pulse, OFF pulse, holiday
- ASTRO channel. Carries out programs of astronomical type, i.e. in the interval delimited by sunrise and sunset*: ON/OFF, ON pulse, OFF pulse, holiday, night programs (see pages 36-37). ON switchings set before sunset are carried out at sunset, OFF switchings set after sunrise are carried out at sunrise (except for some night programs that can have switching on or switching off during the day. See on page 36).

* times of sunrise and sunset are automatically calculated by memo BT according to geographic coordinates set during installation. In place of sunrise and sunset times it's possible to use the times of civil twilight (see page 18).

- ⚠ Important:** on the same channel can't coexist ON pulses and OFF pulses (if an ON pulse is already present, it's not possible to save a holiday OFF program and vice versa).
- ⚠ Important:** on the same channel can't coexist holiday ON programs and holiday OFF programs (if a holiday ON program is already present, it's not possible to save a holiday OFF program and vice versa).
- ⚠ Important:** a channel may be either of clockwise or of astronomical type, but it can't be of both types simultaneously. It's not possible to save programs of astronomical type on a channel where are stored programs of time type (and vice versa).
Messages of $\text{ERROR } \square \text{ ! !}$ (astro program on channel astro) and $\text{ERROR } \square \text{ ! 2}$ (time program on astro channel).
In this case to proceed it's necessary to delete the saved programs on that channel (see page 49).

Programs priority

The priority programs defines how memo BT manages the case in which programs with different period are running at the same time (1 indicates higher priority).

Program	Date*	Annual	Monthly	Weekly	Daily
Holiday			1		
Night			2		
Pulse			3		
On/Off	4	5	6	7	8

- * Date: select day, month, year (program carried "only once in the life of the product").
If the month is not specified, the program is carried out all days xx of all months of the specified year.

Priority list on/off

In case in which, on the same channel, on/off programs are provided with different period (daily or weekly) to carry out in the same day, only the program with the highest priority is executed.

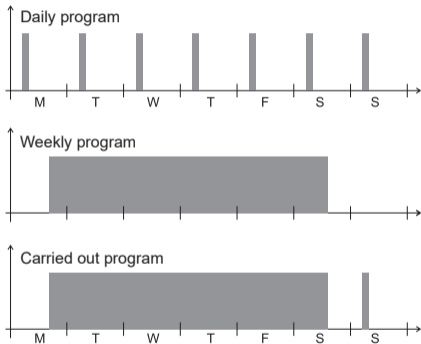

From this example it's possible to see that the daily event on Monday is not carried out because in the same day it is provided the beginning of the week program (even if the daily program

of Monday begins and ends before the beginning of the weekly program). Instead, the daily program of Sunday is carried out because it's the only one running for that day.

Holiday program

The holiday program just begins and ends exactly at the specified times.

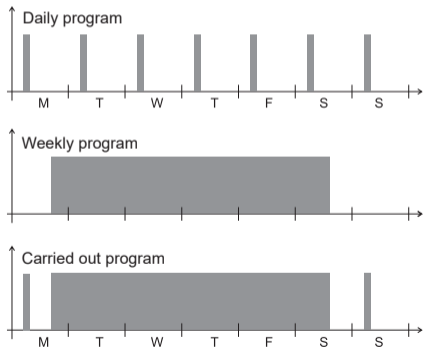

Program menu: new

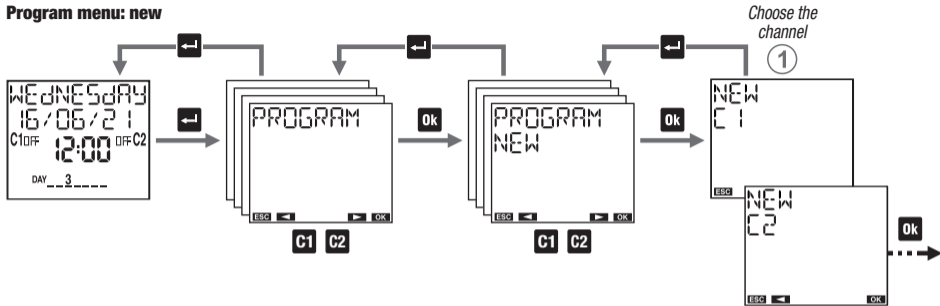

① Choose the channel to program (only for memo BT2 and memo BT Y2)

Program menu: new daily timed

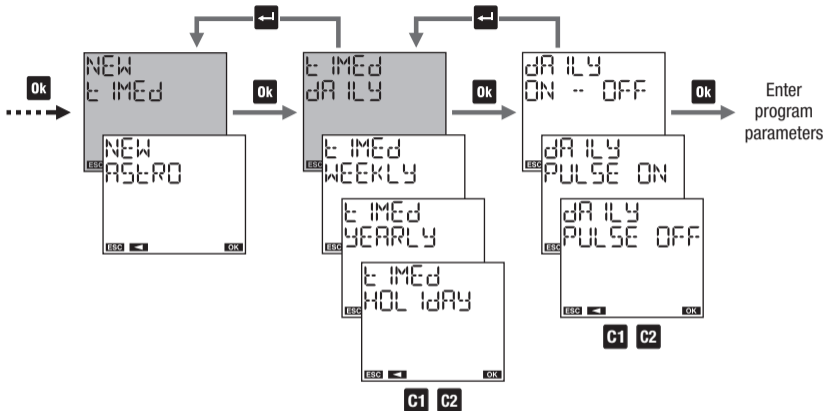

Program parameters

- on/off: on time and off time
- on pulse: time and pulse duration (max 59 seconds)
- off pulse: time and pulse duration (max 59 seconds)

Program menu: new weekly timed

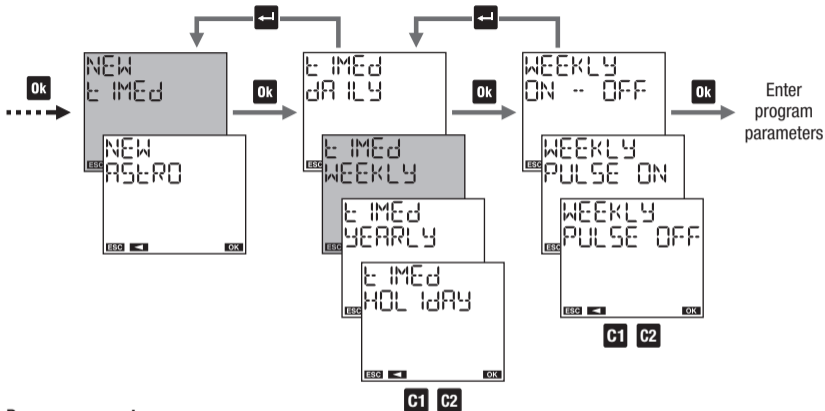

Program parameters

- on/off: day (or days)* and on time, day (or days) and off time
- on pulse: day (or days)* and pulse time, pulse duration (max 59 seconds)
- off pulse: day (or days)* and pulse time, pulse duration (max 59 seconds)

* See "Select days" on page 23

Program menu: new yearly timed

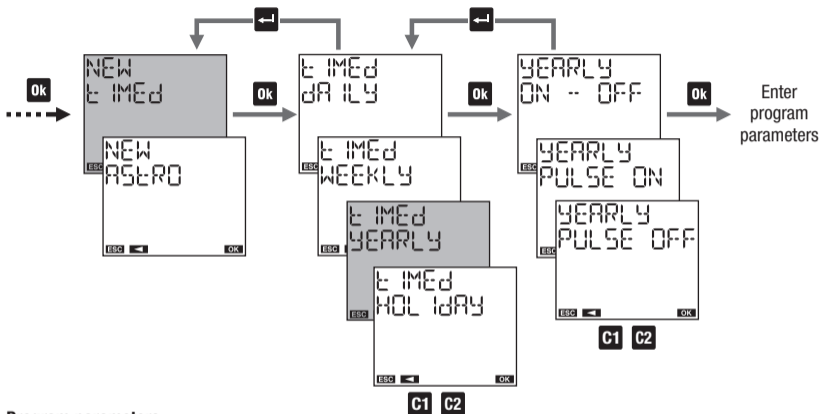

Program parameters

- on / off: day (or days) * and on time, day (or days) and off time
- on pulse: day (or days) * and pulse time, pulse duration (max 59 seconds)
- off pulse: day (or days) * and pulse time, pulse duration (max 59 seconds)

* see "How to choose the day (or days) in a yearly program" on p. 31

How to choose the day (or days) in a yearly program



① to set the program:

in the first, second, third, fourth or last week of the month
in / the day/s (Monday, ...) of the week just specified
the specified month (MM for all months)
the given year (YY for all years)

Nota: in this case, the yearly program must begin and end
in the same day. Otherwise ERROR 0 0 is signaled.

② to set the program on the last day:

---/MM/YY of all months of all years
---/VV/YY of the specified VV month of all years
---/MM/ZZ of all months of the specified ZZ year
---/VV/ZZ of the specified VV month of the specified ZZ year

③ to set the program on the day XX (1,2,3...):

xx/MM/YY of all months of all years
xx/VV/YY of the specified VV month of all years
xx/MM/ZZ of all months of the specified ZZ year
xx/VV/ZZ of the specified VV month of the specified ZZ year

Program menu: new holiday timed

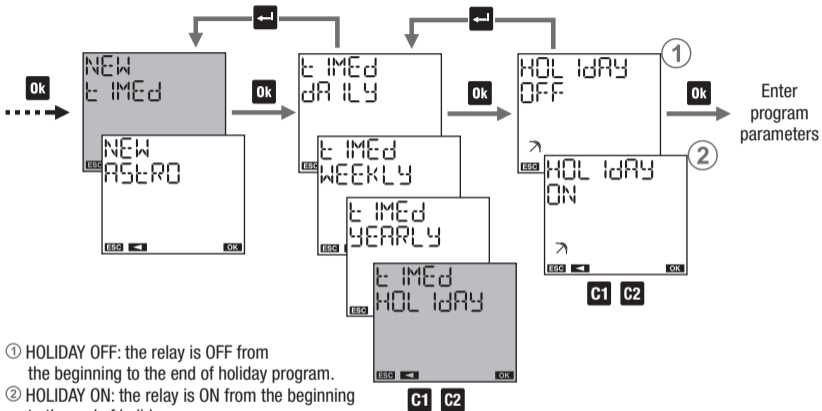

Program parameters

- beginning of the program
- end of the program

How to choose the day (or days) in a holiday program



① to set the program:

in the first, second, third, fourth or last week of the month
 in / the day/s (Monday, ...) of the week just specified
 the specified month (MM for all months)
 the given year (YY for all years)

Nota: in this case, the holiday program must begin and end in the same day. Otherwise ERROR 0 0 is signaled.

② to set the program on the last day:

--- /MM /YY of all months of all years
 --- /VV /YY of the specified VV month of all years
 --- /MM /ZZ of all months of the specified ZZ year
 --- /VV /ZZ of the specified VV month of the specified ZZ year

③ to set the program on the day XX (1,2,3...):

x x /MM /YY of all months of all years
 x x /VV /YY of the specified VV month of all years
 x x /MM /ZZ of all months of the specified ZZ year
 x x /VV /ZZ of the specified VV month of the specified ZZ year

Program menu: new astro night

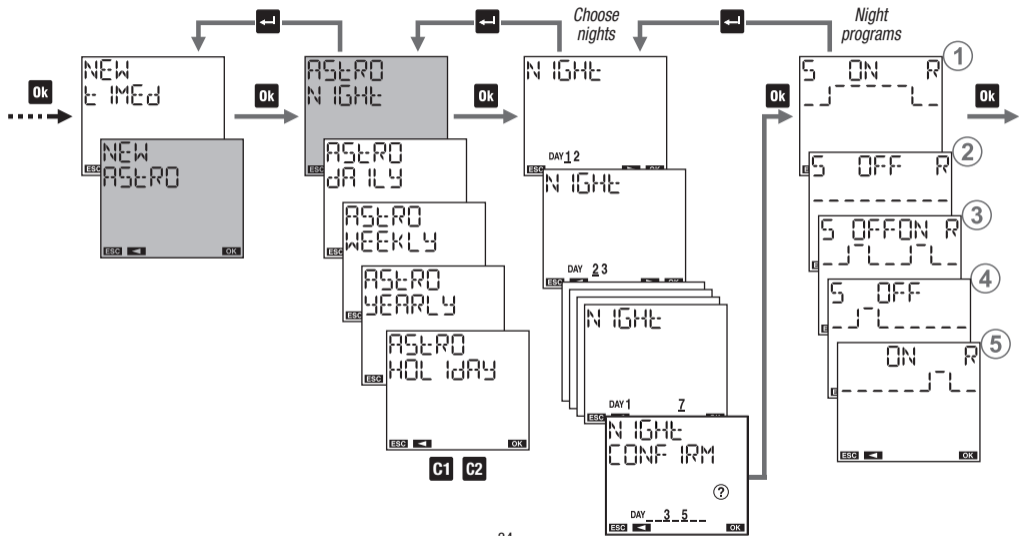

English

How to select nights

scroll through the nights of the week from the first (1-2) to the last (7-1):

- by pressing the key **C2** key to move to the next night without selecting the current night
- by pressing the key **OK** to select/deselect the current night and move to the next



How to interpret the selection

If the night between the days of A and B is selected, the day A is on and underlined while B is on (not underlined).

Examples of selection:

DAY 12345 Selected nights: between day 1 and 2, between day 2 and 3, between day 3 and 4, between day 4 and 5

DAY 12345 Selected nights: between day 1 and 2, between day 2 and 3, between day 4 and 5

DAY 1234 7 Selected nights: between day 1 and 2, between day 3 and 4, between day 7 and 1

Night programs

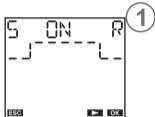

- ① Turning on at sunset, turning off at sunrise.
No parameter required.

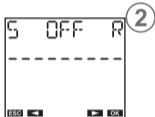

- ② Off from sunset to sunrise.
No parameter required.



- ③ Turning on at sunset, turning off during the night. Turning on during the night, turning off at sunrise.

Choose one of the three following cases:



- Turning on at sunset, turning off at a settable time.
Turning on at a settable time, turning off at sunrise. (*)



- Turning on at sunset, turning off after a settable time interval.
Turning on before sunrise of a settable time interval, turning off at sunrise.



- Turning on at sunset for a settable short duration (pulse, max 59 seconds).
Turning on at sunrise for a short settable duration (pulse, max 59 seconds).

* If off time is before sunset, switching is not carried out. If on time is after sunrise, switching is not carried out.

** Switching on continues for the entire set time interval (also if off time is after sunrise).

*** Switching on occurs before sunrise of the entire set time interval (also if on time is before sunset).

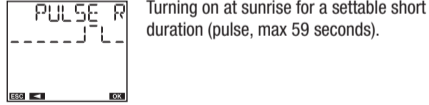
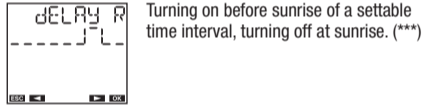
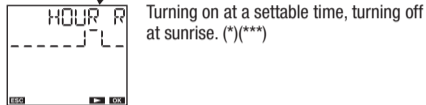
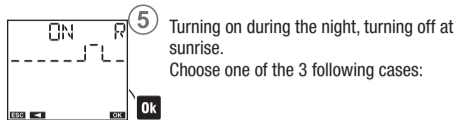
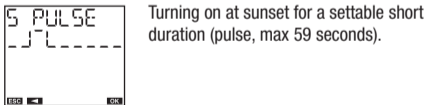
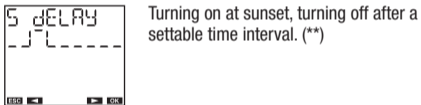
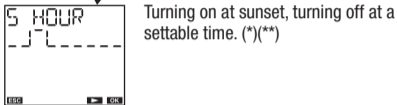
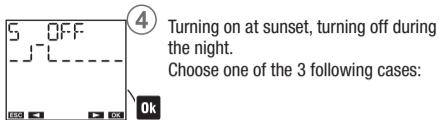

Program menu: new astro daily

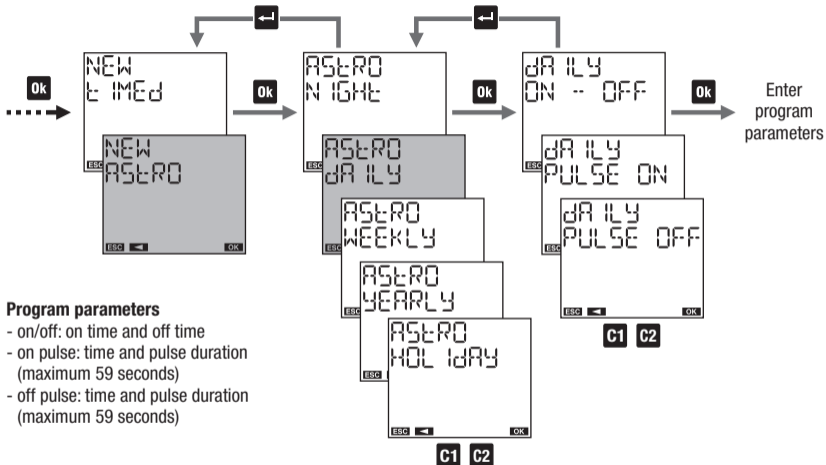

Program menu: new astro weekly

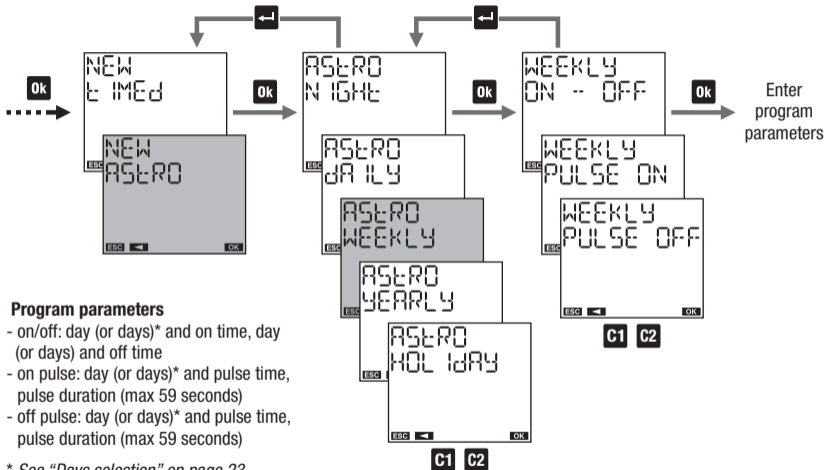

Program menu: new astro yearly

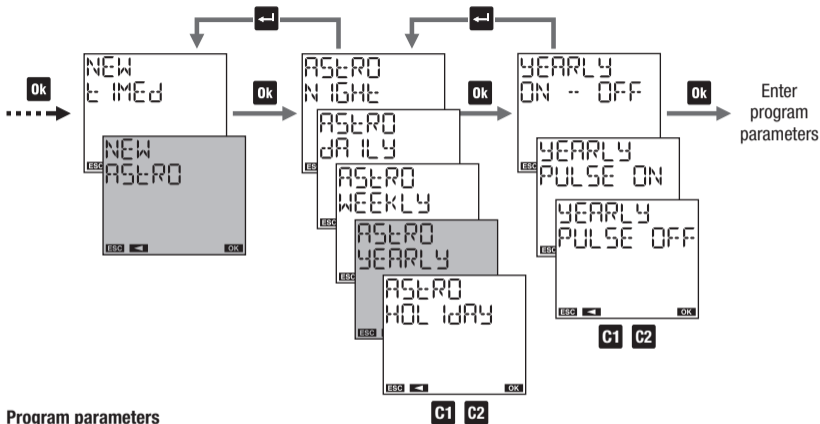

Program parameters

- on / off: day (or days) * and on time, day (or days) and off time
- on pulse: day (or days) * and pulse time, pulse duration (max 59 seconds)
- off pulse: day (or days) * and pulse time, pulse duration (max 59 seconds)

* see "How to choose the day (or days) in a yearly astro program" on p. 41

How to choose the day (or days) in a new astro yearly



① to set the program:

in the first, second, third, fourth or last week of the month
in / the day/s (Monday, ...) of the week just specified
the specified month (MM for all months)
the given year (YY for all years)

Nota: in this case, the yearly program must begin and end
in the same day. Otherwise ERROR 0 0 is signaled.

② to set the program on the last day:

---/MM/YY of all months of all years
---/VV/YY of the specified VV month of all years
---/MM/ZZ of all months of the specified ZZ year
---/VV/ZZ of the specified VV month of the specified ZZ year

③ to set the program on the day XX (1,2,3...):

xx/MM/YY of all months of all years
xx/VV/YY of the specified VV month of all years
xx/MM/ZZ of all months of the specified ZZ year
xx/VV/ZZ of the specified VV month of the specified ZZ year

Program menu: new astro holiday

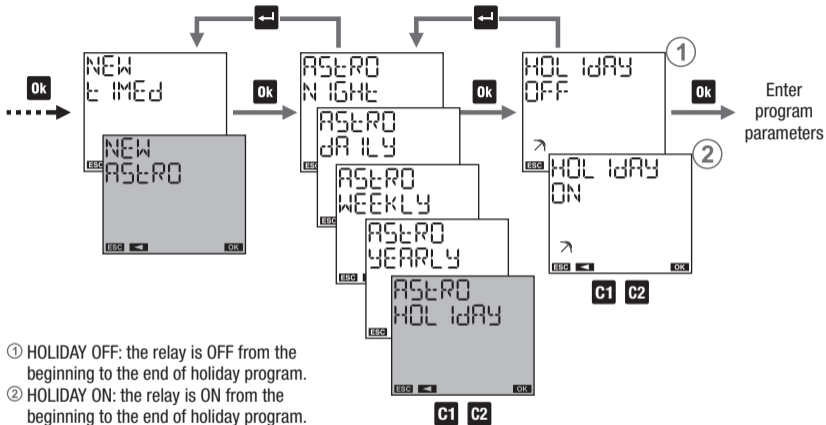

Program parameters

- beginning of the program
- end of the program

How to choose the day (or days) in a holiday astro program

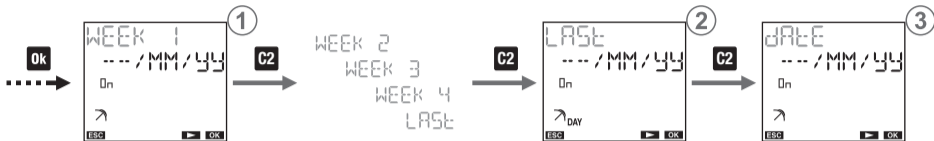

① to set the program:

in the first, second, third, fourth or last week of the month
in / the day/s (Monday, ...) of the week just specified
the specified month (MM for all months)
the given year (YY for all years)

Note: in this case, the holiday program must begin and end in the same day. Otherwise ERROR □ □ is signaled.

② to set the program on the last day:

---/MM/YY of all months of all years
---/VV/YY of the specified VV month of all years
---/MM/ZZ of all months of the specified ZZ year
---/VV/ZZ of the specified VV month of the specified ZZ year

③ to set the program on the day XX (1,2,3...):

xx/MM/YY of all months of all years
xx/VV/YY of the specified VV month of all years
xx/MM/ZZ of all months of the specified ZZ year
xx/VV/ZZ of the specified VV month of the specified ZZ year

Program menu: check

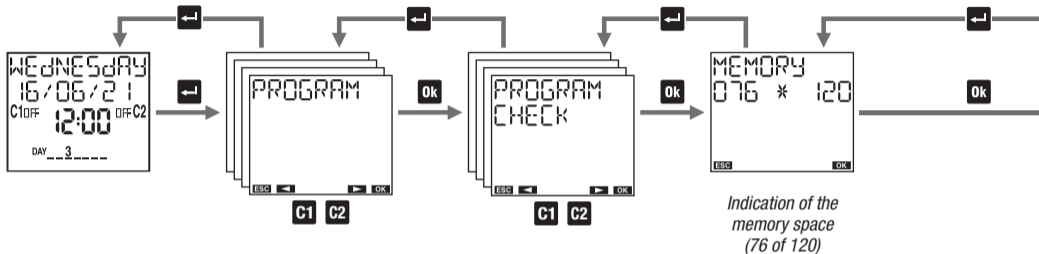

How to check a program

- ① choose the channel (only for memo BT2 and memo BT Y2)
- ② choose the period: daily, weekly, yearly, annual, holiday or night (when it is a channel of astronomical type)
- ③ choose the type: on/off, on pulse, off pulse or a night program (only if it is a channel of astronomical type)

Note: a program requires more screens to be displayed:

- press the key **Ok** to move from the first to the second part of the same program
- press the keys **C1** and **C2** to switch from one program to another

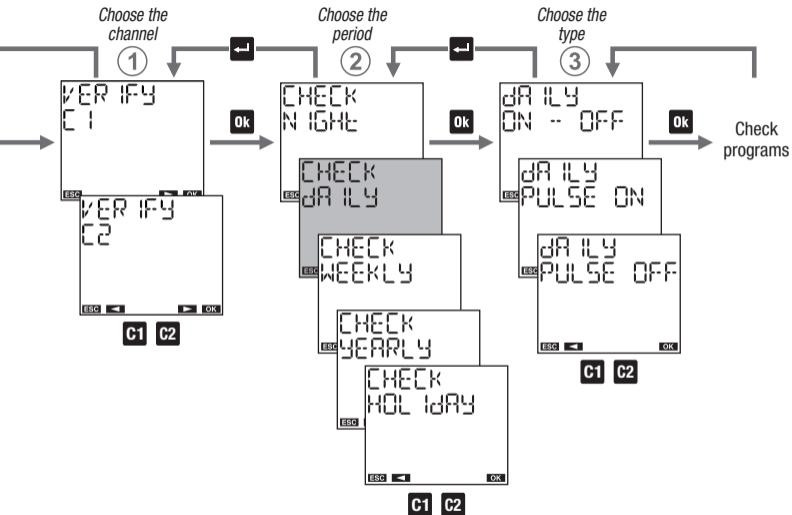

Program menu: modify

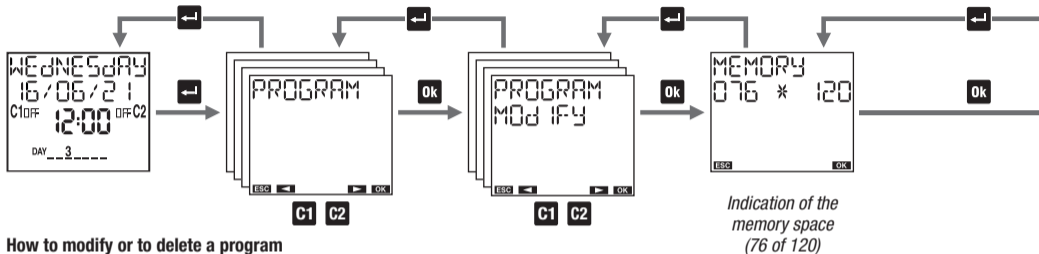

How to modify or to delete a program

- ① choose the channel (only for memo BT2 and memo BT Y2).
- ② choose the period: daily, weekly, yearly, holiday or night (only if it's an astronomical channel)
- ③ choose the type: on/off, on pulse, off pulse or a night program (only if it's an astronomical channel)

Note: a program requires more screens to be displayed:

- press the key **OK** to move from the first to the second part of the same program
- press the keys **C1** and **C2** key to switch from one program to another

To modify: press for a long time (at least 3 seconds) the key **OK**

To delete: press for a long time and simultaneously the keys **OK** and **←**

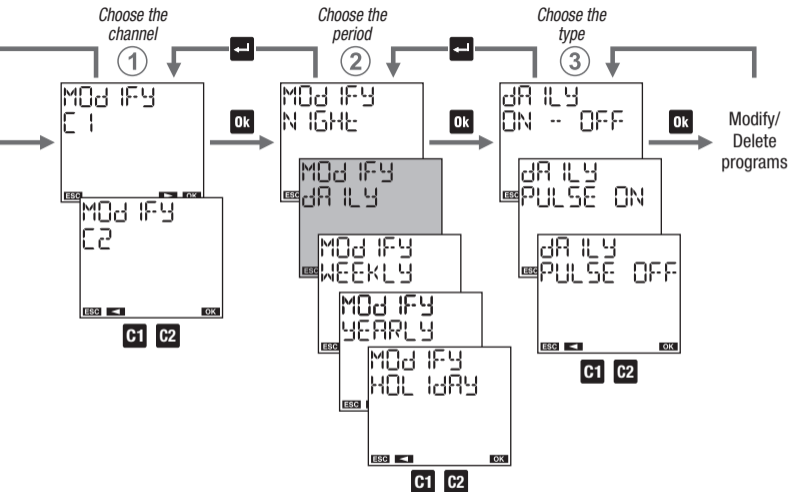

Program menu: copy (only for memo BT2 and memo BT Y2)

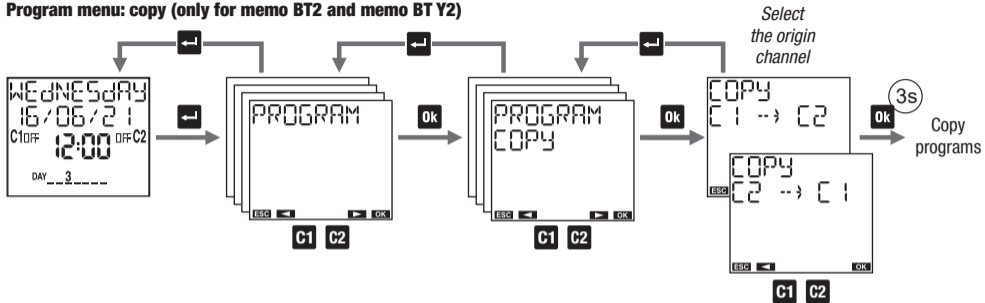

“Copy” menu allows copying the programs of a channel (channel origin) on the other channel (channel destination).
Note: the programs previously stored on the channel destination will be deleted.

Program menu: delete

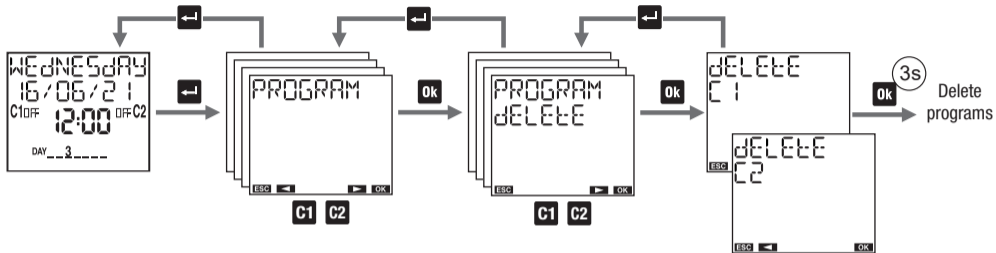

"Delete" menu is used to delete all stored programs on the specified channel.
Note: to delete one single program to see "modify" mode (see page 46).

BLUETOOTH MENU

The Bluetooth menu allows you to enable or disable the Bluetooth interface and change the password used to associate your device (smartphone or tablet) to memo BT.

To enable the Bluetooth interface:

- ① set Bluetooth ON

Warning: to make the Bluetooth interface active, the memo BT must be mains powered and connected to the main page (see page 8). The Bluetooth interface is therefore not active when browsing through the memo BT menus.

To disable the Bluetooth interface:

- ② set Bluetooth OFF

In this way no communication can take place between your device and memo BT. memo BT works with the settings and programs already set; any changes or creation of new programs must be made by acting directly on the keyboard of memo BT.

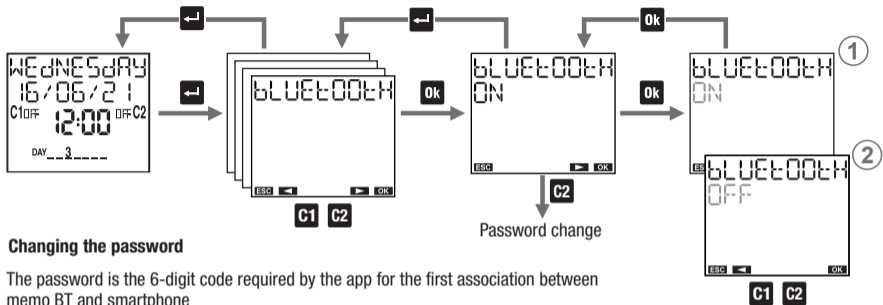

Changing the password

The password is the 6-digit code required by the app for the first association between memo BT and smartphone

The pre-set password is 123456 but can be changed.

①A Press the key **Ok** for at least 3 seconds until the first digit of the password starts to flash.

①B Set the first digit with the keys **C1** and **C2** keys and press the key **Ok** to confirm and move to the next digit.

①C Repeat step ①B to set all 6 digits.

After confirming the last digit, the display shows the new password.

Press the key **↵** to exit the menu.

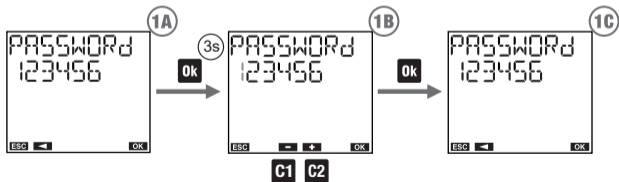

HOUR COUNTER MENU

“Hour counter” menu allows you to display the hours of use (relay on) of connected loads.

The maximum value of the counter is 99999 hours (about 11 years); reached the maximum limit, the counter resets automatically.

To reset a counter:

1. select the desired channel (only for memo BT2 and memo BT Y2)
2. press the key **OK** for 3 seconds until the display shows “HOUR CNT DELETE ?”
3. confirm by pressing **OK** (press **←** to exit without zeroing)

Note: it's possible to reset all counters contemporary from the “Reset” menu (see page 54).

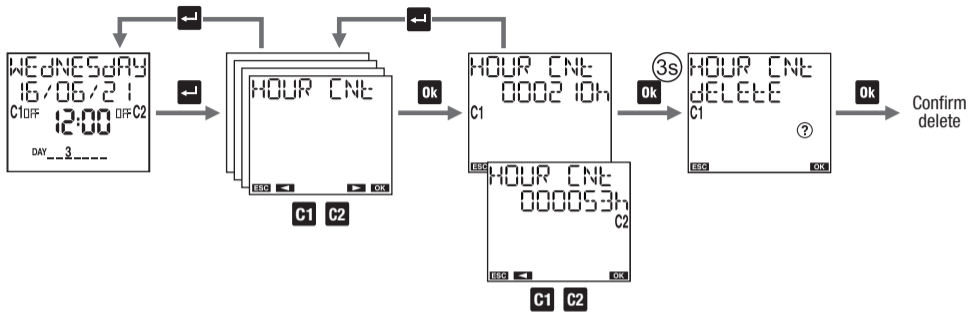

RESET MENU

“Reset” menu allows you to restore the initial state of the device.

Available resets:

- ① Settings reset: deletes all the carried out settings (except the language and the PIN)
- ② Time programs reset: deletes all saved time programs
- ③ Holiday programs reset: deletes all saved holiday programs
- ④ Astro programs reset: deletes all saved astronomical programs
- ⑤ Counter reset: resets the counters of all channels
- ⑥ Reset all: carries out all the above described resets and deletes the language and PIN protection

There is also another reset, of hardware type, which allows you to reset the device in case it responds to the pressing of the keys so unexpectedly, without losing the carried out settings/programs (only the date and the time are lost).

To carry out a hardware reset:

1. press the key “R” with a sharp object



The hardware reset is also useful when you forget PIN protection. Reset, in fact, unlocks the keyboard for 3 minutes, the necessary time to access the appropriate menu and check/disable PIN.

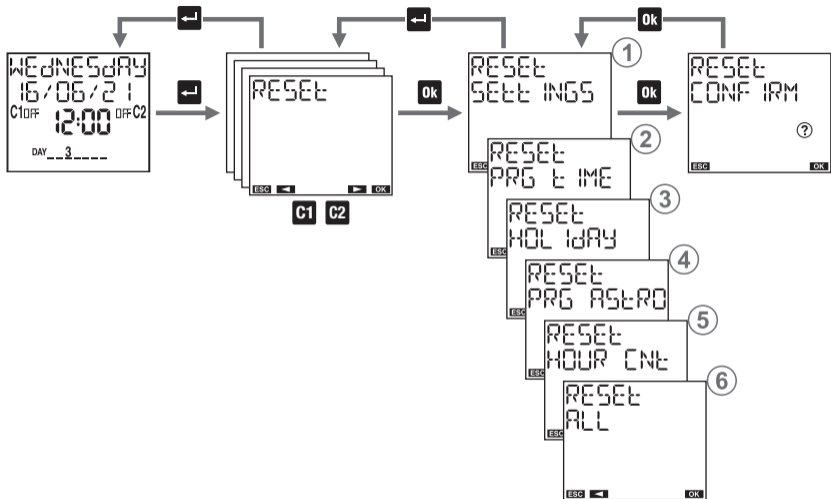

FIRMWARE MENU

This menu shows the firmware installed in the device, where:

022 is the revision index

05 is the month

20 is the day

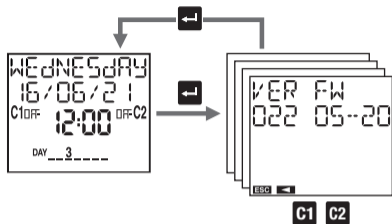

ERROR SIGNALS

When setting up programs, in case of a discrepancy, the following error messages can occur:

- ERROR 001 on and off events with different frequency (each on event must have an off event)
- ERROR 002 on and off concomitant events of the same program
- ERROR 003 Two or more consecutive on events of the same program / Two or more consecutive off events of the same program
- ERROR 004 Invalid date
- ERROR 005 Insufficient memory
- ERROR 006 Attempt to set an on pulse on a channel where is already stored an off pulse (see page 25)
- ERROR 007 Attempt to set an off pulse on a channel where is already stored an on impulse (see page 25)
- ERROR 008 Attempt to set an on holiday program on a channel where is already stored an off holiday program (see page 25)

- ERROR 009 Attempt to set a holiday off program on a channel where a holiday on program is already stored (see page 25)
- ERROR 010 Attempt to set a holiday program of on and off events on different days of the week (see page 33)
- ERROR 011 Attempt to set an astro program on a channel of time (see page 25)
- ERROR 012 Attempt to set a time program on a channel of time type (see page 25)
- ERROR 030 Error accessing memory*

* In this case, carry out a hardware reset (see page 54).
If the error persists, contact Vemer technical support (assistenza.technica@vemer.it).

BATTERY MANAGEMENT

When the battery is close to empty, on the first line of the display appears $\text{E} \text{R} \text{E} \text{R} \text{Y}$. In this case, the battery must be replaced as soon as possible. **Use only batteries of CR2032.**

To replace the battery:

- disconnect the mains
- remove the battery slot cover, turning it anti-clockwise and replace the battery
- remount the cover, turning it clockwise
- connect the power supply

Warning: do not use metal objects (such as screwdrivers) to remove the battery because this may cause the power reserve to be canceled, resulting in a loss of date and time.

Warning: in order not to lose the programming steps and carried out settings, it is necessary to ensure that the time for the battery replacement doesn't exceed 60 seconds (in absence of power by means).



Dispose of the used batteries observing the laws in force in relation to the disposal of hazardous waste.

REFERENCE STANDARDS

EU CONFORMITY DECLARATION

Vemer declares that the device complies with the EU directive 2014/53/EU (RED) with reference to the following standards: EN 60730-2-7, ETSI EN 301 489-1, ETSI EN 301 489-17, ETSI EN 300 328

The complete text of EU conformity declaration is available at the Internet address www.vemer.it.



information to users pursuant to art. 14 of the directive 2012/19 / EU of the european parliament and of the council of 4 july 2012 on waste electrical and electronic equipment (WEEE)

If the crossed-out bin symbol appears on the equipment or packaging, this means the product must not be included with other general waste at the end of its working life.

The user must take the worn product to a sorted waste center, or return it to the retailer when purchasing a new one.

Products for disposal can be consigned free of charge (without any new purchase obligation) to retailers with a sales area of at least 400 m², if they measure less than 25 cm.

An efficient sorted waste collection for the environmentally friendly disposal of the used device, or its subsequent recycling, helps avoid the potential negative effects on the environment and people's health, and encourages the re-use and/or recycling of the construction materials.



Vemer S.p.A.

I - 32032 Feltre (BL) • Via Camp Lonc, 16
e-mail: info@vemer.it - web site: www.vemer.it

08-2022

V3IS00947-020-082022