



## 2 MODELS

### Oikos Wi-Fi



Code	Model	Description
VE796000	Oikos Wi-Fi Bianco	Flush-mounting Wi-Fi chronothermostat 2 modules*
VE796100	Oikos Wi-Fi Grigio	Flush-mounting Wi-Fi chronothermostat 2 modules*

\* Including plastic supports for adaptability to the plates of the main civil series of ABB, AVE, BTICINO, GEWISS and VIMAR.

### Oikos Wi-Fi.NOW



Code	Model	Description
VE796002	Oikos Wi-Fi.NOW Bianco	Flush-mounting Wi-Fi chronothermostat 2 modules*
VE796202	Oikos Wi-Fi.NOW Nero	Flush-mounting Wi-Fi chronothermostat 2 modules*
VE796302	Oikos Wi-Fi.NOW Sabbia	Flush-mounting Wi-Fi chronothermostat 2 modules*

\* Includes plastic support for adaptability to the BTICINO Living Now plate.

### Oikos Wi-Fi-INT



Code	Model	Description
VE796001	Oikos Wi-Fi-INT Bianco	Flush-mounting Wi-Fi chronothermostat 2 modules*
VE796101	Oikos Wi-Fi-INT Grigio	Flush-mounting Wi-Fi chronothermostat 2 modules*

\* Including plastic support for adaptability to the plates of the main civil series of BERKER, BUSCH-JAEGER, GIRA, JUNG and MERTEN

## 3 DESCRIPTION



LED Device configuration/ programming T key

## 4 DIMENSIONS

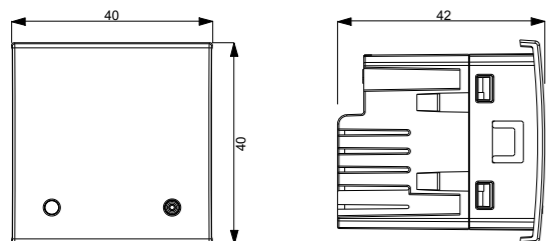

## 1 User Manual FLUSH-MOUNTING WI-FI CHRONOTHERMOSTAT

⚠ Read all the instructions carefully

Compact built-in Wi-Fi chronothermostat suitable to control heating and air conditioning systems with weekly programming and mains power supply. The device is managed exclusively using the app, which is available free of charge for iOS and Android systems. Programming, switching on the system, changing of the operating settings and the creation of new programs are all operations that can be performed easily and from anywhere you are thanks to the integrated Wi-Fi module that connects the device to the Internet through the home router. It comes with adapters that allow it to be installed with the plates of the main civil series. Oikos Wi-Fi is an electronic device that perform actions of 1B type and are intended to operate in environments with III overvoltage category and pollution degree 2 in accordance with EN 60730-1 standard.

### SAFETY WARNINGS

During installation and operation of the device, it is necessary to comply with the following instructions:

- The device must be installed by a qualified person, strictly compliance with the connection diagrams.
- The device must be installed and activated in compliance with current electric systems standards.
- After installation, inaccessibility to the connection terminals without appropriate tools must be guaranteed.
- Do not use the product for anything other than the indicated purpose.
- There must be a bipolar disconnection in the mains supply.
- In the electrical system of the building where the chronothermostat must be installed, a protection device from the overcurrents must be present.
- Before accessing the connection terminals, make sure that the leads are not live.
- Do not power on or connect the device if any part of it is damaged.
- The device performs actions of 1B type and is suitable for environments with pollution degree 2 and overvoltage category III (EN 60730-1).

### TECHNICAL SPECIFICATIONS

- Power supply: 230 Vac (-15 ÷ 10%) 50/60 Hz
- Maximum consumption: 3 VA/230 Vac (in access point mode)
- Output: bistable relay with 5 A/250 Vac interruption power
- Operating mode: summer/winter/off (with antifreeze)
- Weekly programming via app with 3 temperature levels T1, T2, T3
- Programming resolution: 1 hour
- Interval between two measurements: 20 seconds
- Adjustment type: on/off or proportional
- Installation on rectangular recessed boxes with a height of 45 mm or round boxes with a diameter of 60 mm
- Terminal block for cables with a maximum section of 1.5 mm<sup>2</sup>
- Configuration/programming T key
- 3-colour operation status signal LED
- Measurement accuracy: ±0.5°C
- Measured temperature resolution: 0.1°C
- Temperature setting field: 2 ÷ 50°C
- Bluetooth communication interface: BLE 5.0
- Bluetooth operating frequency band: 2400-2483.5 MHz
- Maximum Bluetooth radiofrequency power transmitted: 4 dBm
- Wi-Fi operating frequency band: 2.4 GHz IEEE 802.11 b/g/n
- Maximum transmitted Wi-Fi radiofrequency power: 18.3 dBm
- Operating temperature: 0°C ÷ 50°C
- Storage temperature: -10 ÷ 65°C
- Operating humidity: 20% ÷ 90% non-condensing
- Protection degree: IP40
- Insulation: reinforced among accessible parts (front) and all the other clamps



Information to users pursuant to art. 14 of the directive 2012/19 / EU of the european parliament and of the council of 4 july 2012 on waste electrical and electronic equipment (WEEE)

If the crossed-out bin symbol appears on the equipment or packaging, this means the product must not be included with other general waste at the end of its working life.

The user must take the worn product to a sorted waste center, or return it to the retailer when purchasing a new one.

Products for disposal can be consigned free of charge (without any new purchase obligation) to retailers with a sales area of at least 400 m<sup>2</sup>, if they measure less than 25 cm.

An efficient sorted waste collection for the environmentally friendly disposal of the used device, or its subsequent recycling, helps avoid the potential negative effects on the environment and people's health, and encourages the re-use and/or recycling of the construction materials.

## REFERENCE STANDARDS

EU Declaration of Conformity:  
Vemer declares that the device complies with EU Directive 2014/53/EU (red) with reference to the following standards:  
• EN 60730-2-7 • EN 60730-2-9 • ETSI EN 300 328 • ETSI EN 301 489-1 • ETSI EN 301 489-17  
The full text of the EU Declaration of Conformity is available at the Internet address [www.vemer.it](http://www.vemer.it)

11-2023

## 5 CONNECTION DIAGRAM

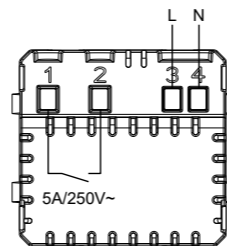

## 6a OIKOS WI-FI / OIKOS WI-FI.NOW MOUNTING

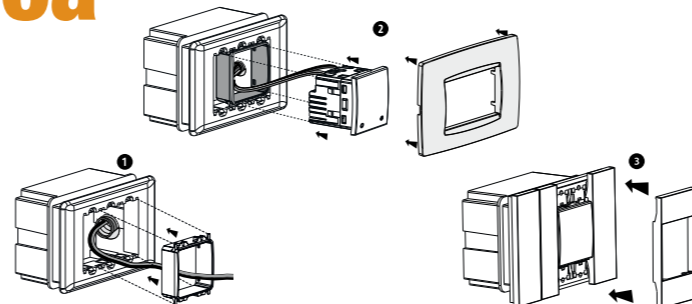

- Apply the adapter corresponding to the civil series plate to be assembled (see BOX 8)
- Connect the load and power supply (see connection diagram), insert the device into the adapter and secure the supplied civil series plate
- With the BTicino Living Now series, also insert the closing frame

## 6b OIKOS WI-FI-INT MOUNTING

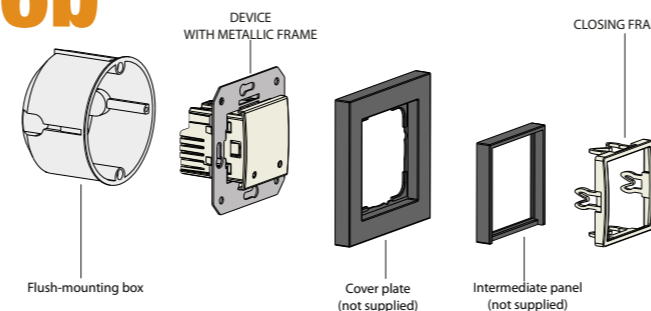

- Connect the load and power supply (see connection diagram)
- Attach the device with the metal frame to the built-in box
- Apply the cover mask and any intermediate panel 50x50 mm
- Finally insert the closing frame (white / grey colours)

The device can be adapted to the cover masks of Berker, Busch-Jaeger, Gira, Jung and Merten. The complete list of compatible mask models is available on the website [www.vemer.it](http://www.vemer.it) on the product page.

## 7 ⚠ WARNINGS FOR THE CORRECT POSITIONING AND CONNECTION OF THE DEVICE TO A WI-FI NETWORK

### WARNINGS

**The use of the chronothermostat via the Clima APP must be carried out in the presence of a Wi-Fi network connected to the Internet. The smartphone used for setup must be connected to the same Wi-Fi network. Make sure you have a Vemer account available.**

### POSITIONING

- It is recommended to install the device at a height of 1.5 meters from the floor, in an area that reflects as much as possible the average temperature conditions of the room.
- Avoid installation near doors or windows, in niches, behind doors and curtains or in positions with excess or total lack of ventilation.
- Also make sure that the distance from the router is such that stable communication is guaranteed.

## 8 ADAPTERS

The device, depending on the model, comes with adapters that allow it to be installed with the plates of the main civil series.

### Oikos Wi-Fi

Code	Adapter	Series
VE796000 VE796100	AM	ABB: Mylos
	A4	AVE: S44
	BA	BTICINO: Axolute, Axolute AIR
	BL	BTICINO: Light, Living International, LivingLight, LivingLight AIR
	GC	GEWISS: Chorus
	VE	VIMAR: Arké, Eikon, Eikon Evo
VP	VIMAR: Plana	

### Oikos Wi-Fi.NOW

Code	Adapter	Series
VE796002 VE796202 VE796302	LN-2	BTICINO: Living Now

### Oikos Wi-Fi-INT

Code	Adapter	Series
VE796001 VE796101	-	BERKER, BUSCH-JAEGER, TOUR, JUNG, MERTEN.

- All trademarks in the document are registered by their rightful owners.

## 9 PRELIMINARY OPERATIONS

For the correct operation and use of the device through the remote control via the App, carefully follow the points below:

- Install and connect the device according to the connection diagrams in this manual.

- Check that:

- the Router and/or the Wi-Fi Access Point are correctly switched on and at a distance such as to guarantee a stable communication signal with the device
- the Router has full access to the Internet and there are no browsing restrictions (firewall settings, parental control,...)
- The 2.4 GHz frequency band is also enabled in the Router settings (the devices do not support the 5 GHz band)
- the smartphone used for configuration is connected to the same Wi-Fi network to which the device is connected

- Create a Vemer account:

- Install and launch the **Clima** app on your smartphone (or tablet)

- Choose "**REGISTER NOW**" and fill in the "e-mail" and "password" fields

Nota: for security reasons, it is advisable to choose a password different from the one used to access your e-mail inbox

- Check your e-mail: confirm activation of the account by clicking on the link contained in the e-mail sent by the system

- Log in by entering the e-mails and passwords chosen during registration

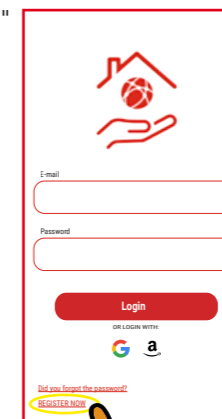

## 10 REMOTE CONTROL CONFIGURATION

To configure the device using a smartphone proceed as follows:

- Check that the phone you are using is connected to the home Wi-Fi network where the device will be connected.
- Launch the **App**, press the "+" key on the Home page, enter a name for the building to be created and press "**Save**".
- Press the "+" key to add a new device and select an area that helps to easily identify it from those proposed.
- In the list of configurable devices, locate and press on the image of the **Oikos** model.

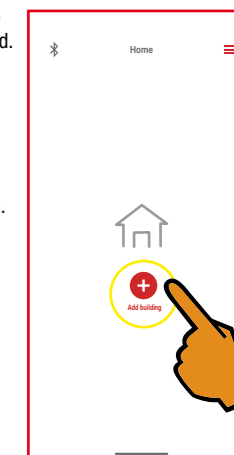

- On the **Oikos Wi-Fi**, briefly press the **T** key. The **green LED** will start to flash quickly for a few seconds, then it will flash slowly for approximately 5 minutes (configuration mode).
- On the **phone** check in the settings that you have activated the Bluetooth connection.
- On the **App**:
  - follow the instructions in the wizard and press "**Next**".
  - find and select in the list the device "**OW\_...**" to connect to the **Oikos Wi-Fi** (the **green LED** will become a steady light to indicate the connection between the app and the device).
  - choose (with Android) or enter (with iOS) the full name of the Wi-Fi network to connect the device to, being sure to faithfully type in all the component characters (uppercase, lowercase, spaces, digits).
  - now enter the password of the Wi-Fi network to which the device is connected, being sure to faithfully type in all the component characters (uppercase, lowercase, spaces, digits). Press "**Next**" to proceed.
- On the **Oikos Wi-Fi** the **orange LED** will start to flash quickly for a few seconds, then it will flash slowly to indicate the correct connection with the home network.
- On the **App**, press "**Connect**" to complete the configuration.

The configuration procedure has ended. At this point: the **App** displays the list of zones associated with your account in which the newly associated device must also appear.

on the **Oikos Wi-Fi** after the device connects with the Vemer Cloud, the LED will turn off (this may take a few minutes).

NOTE: If the configuration operation is unsuccessful and the **orange LED** continues to flash, repeat the configuration procedure of the device with remote control, paying particular attention to entering the required data, faithfully respecting upper and lower case characters, digits and spaces.

## 11 DEVICE RESET

The reset procedure deletes all the settings made as well as the configuration of the connection with the home network and returns the device to the factory conditions.

To reset using a smartphone proceed as follows:

- Launch the **App** and press the "⌘" key in the top left of the Home page.
- Follow the instructions in the wizard and press "**Next**".
- On the **Oikos Wi-Fi** press the **T** key. The **green LED** will start to flash quickly for a few seconds, then it will flash slowly for approximately 5 minutes (configuration mode).
- On the **phone** check in the settings that you have activated the Bluetooth connection.
- On the **App**:
  - follow the instructions in the wizard and press "**Next**".
  - find and select in the list the device "**OW\_...**" to connect to the **Oikos Wi-Fi** (the **green LED** will become a steady light to indicate the connection between the app and the device)
  - select the "**Reset**" key and confirm.

The reset procedure has ended. At this point: the **App** displays the reset message allowing you to return to the Home page on the **Oikos Wi-Fi** the **orange LED** will light up for a few seconds to signal the restart phase and will then start flashing slowly.

Now it is possible to proceed with the configuration of the device described in BOX 10.

## 12 WHAT TO DO IF THE ROUTER IS REPLACED

In case of replacement of the Router/Access Point of the home network or if it is necessary to change the network settings entered in the device (SSID network name or password) configure the device described in BOX 10.

⚠ **Important:** Do not remove/delete the device from the application of the user with whom the device is associated before proceeding with the configuration procedure.

## 13 HOW TO DELETE DEVICE ASSOCIATION FROM AN ACCOUNT (DE-LINK)

If it is necessary to assign control of the device to another user (typical situation for example when the device is installed in a rented home and the tenants change), proceed as follows through **using one of the two alternative ways:**

a. on the **old user's phone:**

1. Launch the **App** and access the building in which the device is contained by pressing the **"ENTER"** key.
2. Now locate the device to be disassociated and press the **"⌵"** key to its right.
3. Select the **"Delete"** item in the drop-down menu and confirm.  
The De-Link procedure is finished. At this point wait for the **orange LED** on the **Oikos Wi-Fi** to start flashing slowly (it may take a few minutes).

b. if you do not have the old user's credentials, proceed as follows:

1. Launch the **App** and press the **"⌵"** key in the top left of the Home page.
2. Follow the instructions in the wizard and press **"Next"**.
3. On the **Oikos Wi-Fi** press the **T** key. The **green LED** will start flashing fast for a few seconds and will then flash slowly for approximately 5 minutes (set-up mode).
4. On the **phone** check in the settings that you have activated the Bluetooth connection.
5. On the **App:**
  - a. follow the instructions in the wizard and press **"Next"**
  - b. find and select in the list the device **"OW\_..."** to connect to the **Oikos Wi-Fi** (the **green LED** will become a steady light to indicate the connection between the app and the device)
  - c. select the **"De-Link"** key and confirm.

The De-Link procedure has ended. At this point: the **App** displays the De-Link message allowing you to return to the Home page on the **Oikos Wi-Fi** the **orange LED** will light up for a few seconds to signal the restart phase and will then start flashing slowly.

At the end of one of the 2 procedures it is possible to configure the device described in BOX 10.

## 14 LED SIGNALS

The colours of the LED on the device, based on the types of ignition described in the table, explain the operating status of the device:

Colour	Type of switch on	Operating status
<b>GREEN</b>	Steady on	Bluetooth connection with smartphone (during the configuration phase of the remote control or local operation)
	Fast flashing	Bluetooth mode preparation for connection with smartphone
	Slow flashing	Bluetooth mode on for remote control configuration
<b>YELLOW</b>	Steady on	Switching on of the device or restarting
	Fast flashing	Reporting no Internet connection
	Slow flashing	Device not configured
<b>RED</b>	Steady on	Relay status ON

## 15 HOW TO PROCEED WITHOUT A CONNECTION

In the event that the device cannot reach the Vemer Cloud due to connectivity problems, **LOCAL OPERATION** allows connection to the device through the Bluetooth of your smartphone, allowing programming and configuration of the Chronothermostat without changing the settings in the Cloud. Failure to connect to the Internet is signalled by the quick flashing of the **Orange LED** on the device.

**The device automatically resumes normal operation as soon as the Cloud connection is restored interrupting the programming and configuration of LOCAL OPERATION.**

To activate **Local Operation:**

1. On the **App:**
  - a. access the building in which the device has been configured and once it has been identified, access it by pressing the relative **"ENTER"** key
  - b. access the **Settings** via the menu key in the top right and then select **Advanced Settings**
  - c. select **Local Operation**
2. On the **Oikos Wi-Fi** press the **T** key, the **green LED** will begin to flash quickly for a few seconds and will then flash slowly for approximately 5 minutes.
3. On the **phone** check in the settings that you have activated the Bluetooth connection.
4. On the **App:**
  - a. follow the instructions in the wizard and press **Next**
  - b. find and select in the list the device **"OW\_..."** to connect to the **Oikos Wi-Fi** (the **green LED** will become a steady light to indicate the connection between the app and the device)
  - c. the application will verify and report the problem of no connection:
    - LAN: device not connected to the home router. If this condition persists, check that the home router is powered on and working properly and that the home Wi-Fi network data (SSID network name or password) entered when configuring the device is correct (see BOX 10).
    - NET: device connected to the home router but not connected to the Internet.
    - CLOUD: no connection to the Vemer Cloud. The problem resolves itself once the connection between Cloud Vemer and the device is restored. If this condition persists for more than 24 hours, do not perform any operation and contact Vemer support.
  - d. set the desired temperature value using the **+** and **-** keys and press the **"Save"** key.

During the period of using **Local Operation** on the **App**, on the Device Detail page, the icon appears 

## 16 APP DESCRIPTION

### LOGIN

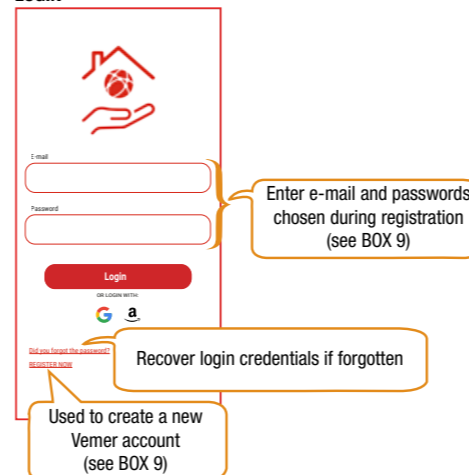

Enter e-mail and passwords chosen during registration (see BOX 9)

Recover login credentials if forgotten

Used to create a new Vemer account (see BOX 9)

### BUILDING

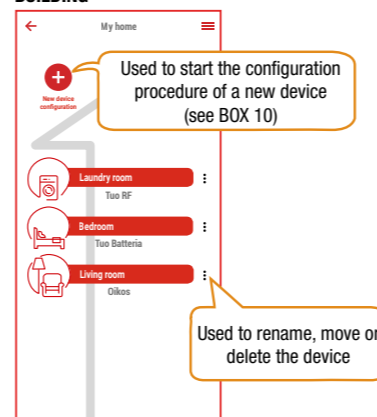

Used to start the configuration procedure of a new device (see BOX 10)

Used to rename, move or delete the device

### PROGRAMS LIST

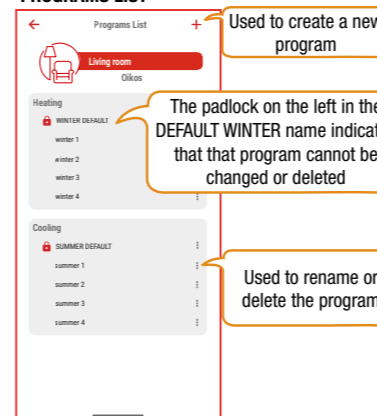

Used to create a new program

The padlock on the left in the DEFAULT WINTER name indicates that that program cannot be changed or deleted

Used to rename or delete the program

### EDIT PROGRAM (PART 2)

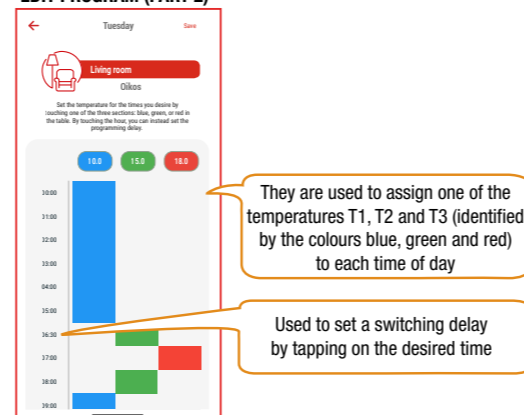

They are used to assign one of the temperatures T1, T2 and T3 (identified by the colours blue, green and red) to each time of day

Used to set a switching delay by tapping on the desired time

### HOME

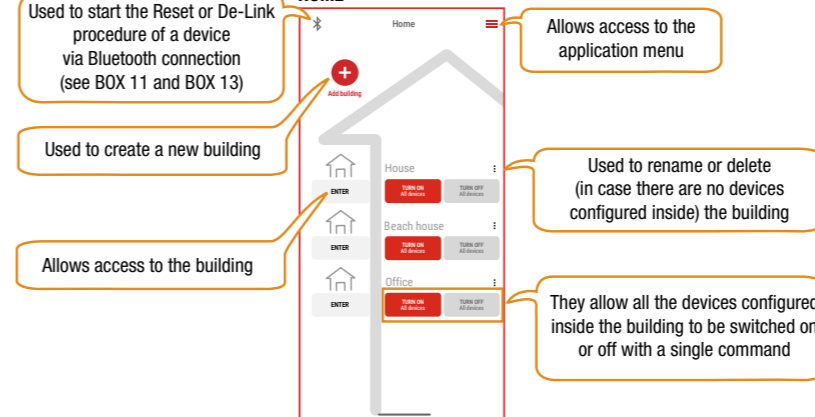

Used to start the Reset or De-Link procedure of a device via Bluetooth connection (see BOX 11 and BOX 13)

Used to create a new building

Allows access to the building

Allows access to the application menu



Used to rename or delete (in case there are no devices configured inside) the building

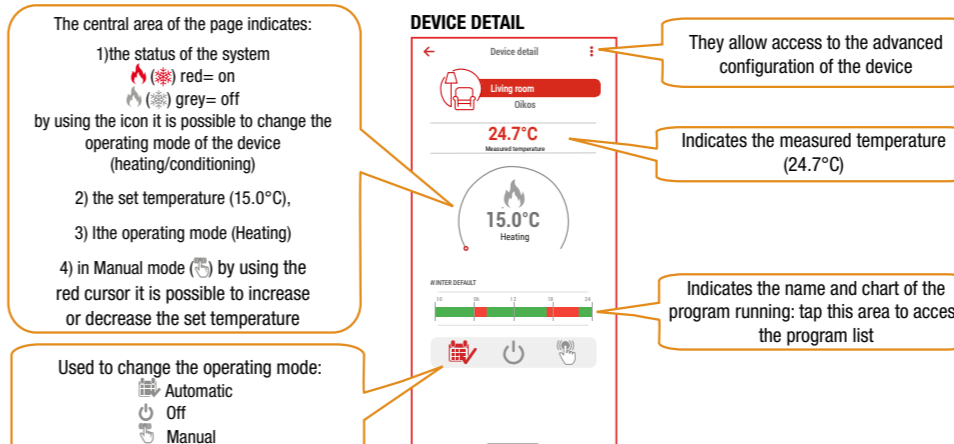

They allow all the devices configured inside the building to be switched on or off with a single command

### DEVICE DETAIL



The central area of the page indicates:

- 1) the status of the system  
 red= on  
 grey= off  
 by using the icon it is possible to change the operating mode of the device (heating/conditioning)
- 2) the set temperature (15.0°C),
- 3) the operating mode (Heating)
- 4) in Manual mode  by using the red cursor it is possible to increase or decrease the set temperature

Used to change the operating mode:  
 Automatic  
 Off  
 Manual

They allow access to the advanced configuration of the device

Indicates the measured temperature (24.7°C)

Indicates the name and chart of the program running: tap this area to access the program list

### PROGRAM CREATION

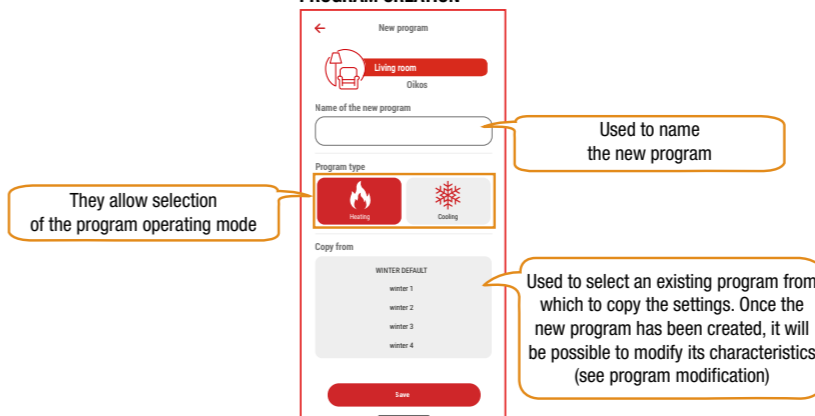

Used to name the new program

They allow selection of the program operating mode

Used to select an existing program from which to copy the settings. Once the new program has been created, it will be possible to modify its characteristics (see program modification)

### SETTINGS

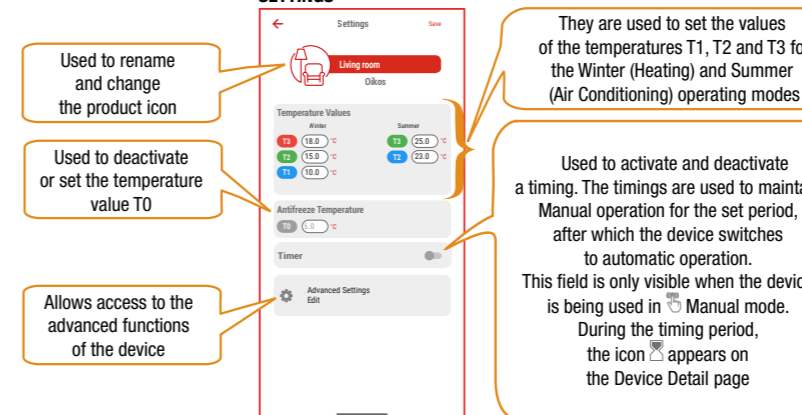

Used to rename and change the product icon

Used to deactivate or set the temperature value T0

Allows access to the advanced functions of the device

They are used to set the values of the temperatures T1, T2 and T3 for the Winter (Heating) and Summer (Air Conditioning) operating modes

Used to activate and deactivate a timing. The timings are used to maintain Manual operation for the set period, after which the device switches to automatic operation. This field is only visible when the device is being used in Manual mode. During the timing period, the icon  appears on the Device Detail page

### APPLICATION MENU

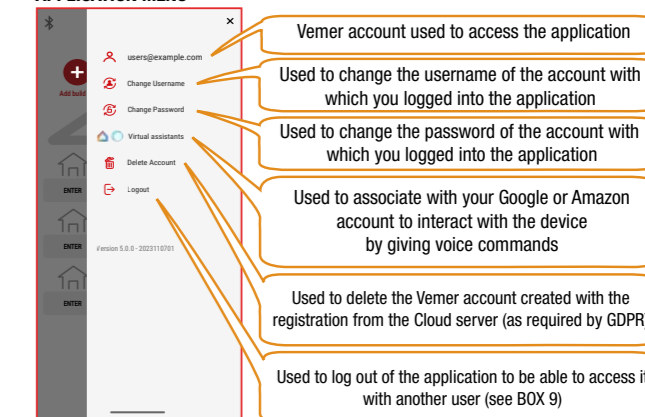

Vemer account used to access the application

Used to change the username of the account with which you logged into the application

Used to change the password of the account with which you logged into the application

Used to associate with your Google or Amazon account to interact with the device by giving voice commands

Used to delete the Vemer account created with the registration from the Cloud server (as required by GDPR)

Used to log out of the application to be able to access it with another user (see BOX 9)

### CONFIGURATION MENU

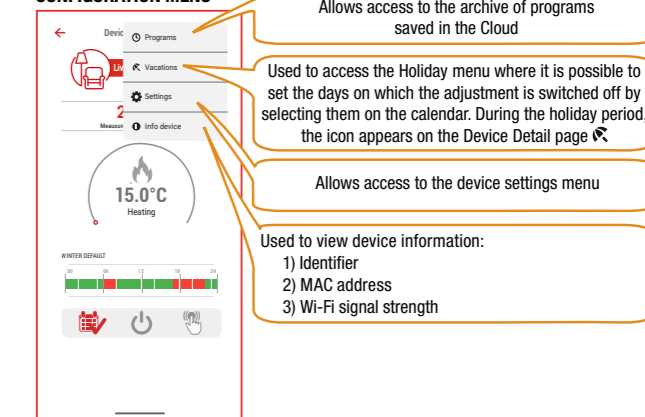

Allows access to the archive of programs saved in the Cloud

Used to access the Holiday menu where it is possible to set the days on which the adjustment is switched off by selecting them on the calendar. During the holiday period, the icon appears on the Device Detail page 

Allows access to the device settings menu

Used to view device information:

- 1) Identifier
- 2) MAC address
- 3) Wi-Fi signal strength

### EDIT SCHEDULE (PART 1)

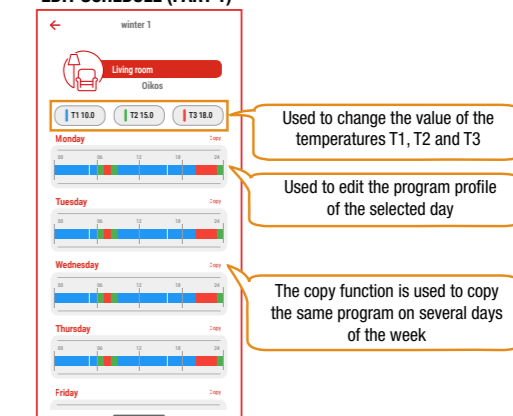

Used to change the value of the temperatures T1, T2 and T3

Used to edit the program profile of the selected day

The copy function is used to copy the same program on several days of the week

### ADVANCED SETTINGS

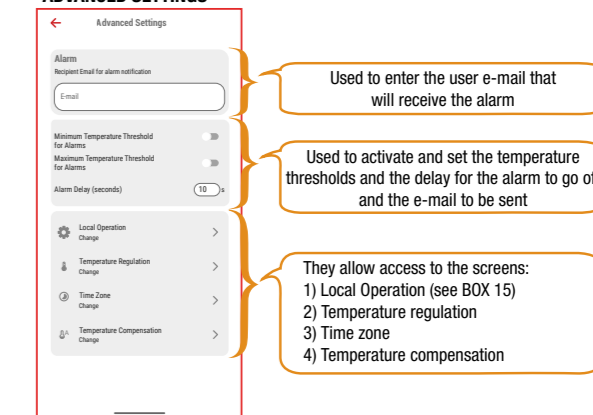

Used to enter the user e-mail that will receive the alarm

Used to activate and set the temperature thresholds and the delay for the alarm to go off and the e-mail to be sent

They allow access to the screens:

- 1) Local Operation (see BOX 15)
- 2) Temperature regulation
- 3) Time zone
- 4) Temperature compensation